

Operator's manual

425 BVS

Please read the operator's manual carefully and make sure you understand the instructions
before using the machine.



English

KEY TO SYMBOLS

Symbols

WARNING! The machine can be a dangerous tool if used incorrectly or carelessly, which can cause serious or fatal injury to the operator or others.



Please read the operator's manual carefully and make sure you understand the instructions before using the machine.



Always wear:

- Hearing protection
- Approved eye protection
- A breathing mask should be used when there is a risk of dust. Wear anti-vibration gloves to reduce the risk of whitefinger disease.



Make sure that the inlet cover is in the closed position or that the vacuum tube is mounted on the blower. Never touch the impeller unless the unit is off, the impeller has stopped moving and the spark plug is disconnected.



The blower can forcibly throw objects that can bounce back. This can result in serious eye injuries if the recommended safety equipment is not used.



The blower operator must ensure that no people or animals come closer than 15 metres.



When several operators are working at the same site a safety distance of at least 15 metres must be in effect.

Other symbols/decals on the machine refer to special certification requirements for certain markets.

Switch off the engine by moving the throttle trigger to idle position and then press the red STOP button until the engine stops completely. Switch off the engine before carrying out any checks or maintenance.

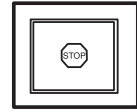

Regular cleaning is required.

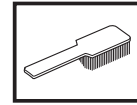

Visual check.



Refuelling.



Choke lever in "open position".



Choke lever in "closed position".



CONTENTS

Contents

KEY TO SYMBOLS

Symbols 2

CONTENTS

Contents 3

Note the following before starting: 3

INTRODUCTION

Dear Customer, 4

WHAT IS WHAT?

What is what on the blower? 5

GENERAL SAFETY PRECAUTIONS

General 6

SAFETY INSTRUCTIONS

Personal protective equipment 8

Machine's safety equipment 8

Checking, maintaining and servicing the machine's safety equipment 9

General working instructions 9

ASSEMBLY

Blow pipe 11

Installing support handle 11

FUEL HANDLING

Fuel 12

Fueling 13

STARTING AND STOPPING

Starting and stopping 14

MAINTENANCE

General 15

Carburettor 15

Muffler 15

Cooling system 15

Air intake screen 16

Spark plug 16

Air filter 16

Fuel filter 17

Maintenance schedule 18

TECHNICAL DATA

Technical data 19

Note the following before starting:

Please read the operator's manual carefully.



WARNING! Long-term exposure to noise can result in permanent hearing impairment. So always use approved hearing protection.



WARNING! Under no circumstances may the design of the machine be modified without the permission of the manufacturer. Always use original accessories. Non-authorized modifications and/or accessories can result in serious personal injury or the death of the operator or others.



WARNING! A blower is a dangerous tool if used carelessly or incorrectly and can cause serious, even fatal injuries. It is extremely important that you read and understand the contents of this Operator's manual.

Husqvarna AB has a policy of continuous product development and therefore reserves the right to modify the design and appearance of products without prior notice.

The machine is only designed for blowing lawns, pathways, asphalt roads and the like.

INTRODUCTION

Dear Customer,

Congratulations on your choice to buy a Husqvarna product! Husqvarna is based on a tradition that dates back to 1689, when the Swedish King Karl XI ordered the construction of a factory on the banks of the Husqvarna River, for production of muskets. The location was logical, since water power was harnessed from the Huskvarna River to create the water-powered plant. During the more than 300 years in existence, the Husqvarna factory has produced a lot of different products, from wood stoves to modern kitchen appliances, sewing machines, bicycles, motorcycles etc. In 1956, the first motor driven lawn mowers appeared, followed by chain saws in 1959, and it is within this area Husqvarna is working today.

Today Husqvarna is one of the leading manufacturers in the world of forest and garden products, with quality as our highest priority. The business concept is to develop, manufacture and market motor-driven products for forestry and gardening, as well as for the building and construction industry. Husqvarna's aim is also to be at the front edge for ergonomics, usability, security and environmental protection. That is the reason why we have developed many different features to add to our products within these areas.

We are convinced that you will appreciate with great satisfaction the quality and performance of our product for a very long time to come. The purchase of one of our products gives you access to professional help with repairs and service whenever this may be necessary. If the retailer who sells your machine is not one of our authorised dealers, ask for the address of your nearest service workshop.

It is our wish that you will be satisfied with your product and that it will be your companion for a long time. Think of this operator's manual as a valuable document. By following its content (usage, service, maintenance, etc), the life span and the second-hand value of the machine can be extended. If you sell this machine, make sure that the operator's manual is passed on to the buyer.

Thank you for using a Husqvarna product.

Husqvarna AB has a policy of continuous product development and therefore reserves the right to modify the design and appearance of products without prior notice.

WHAT IS WHAT?

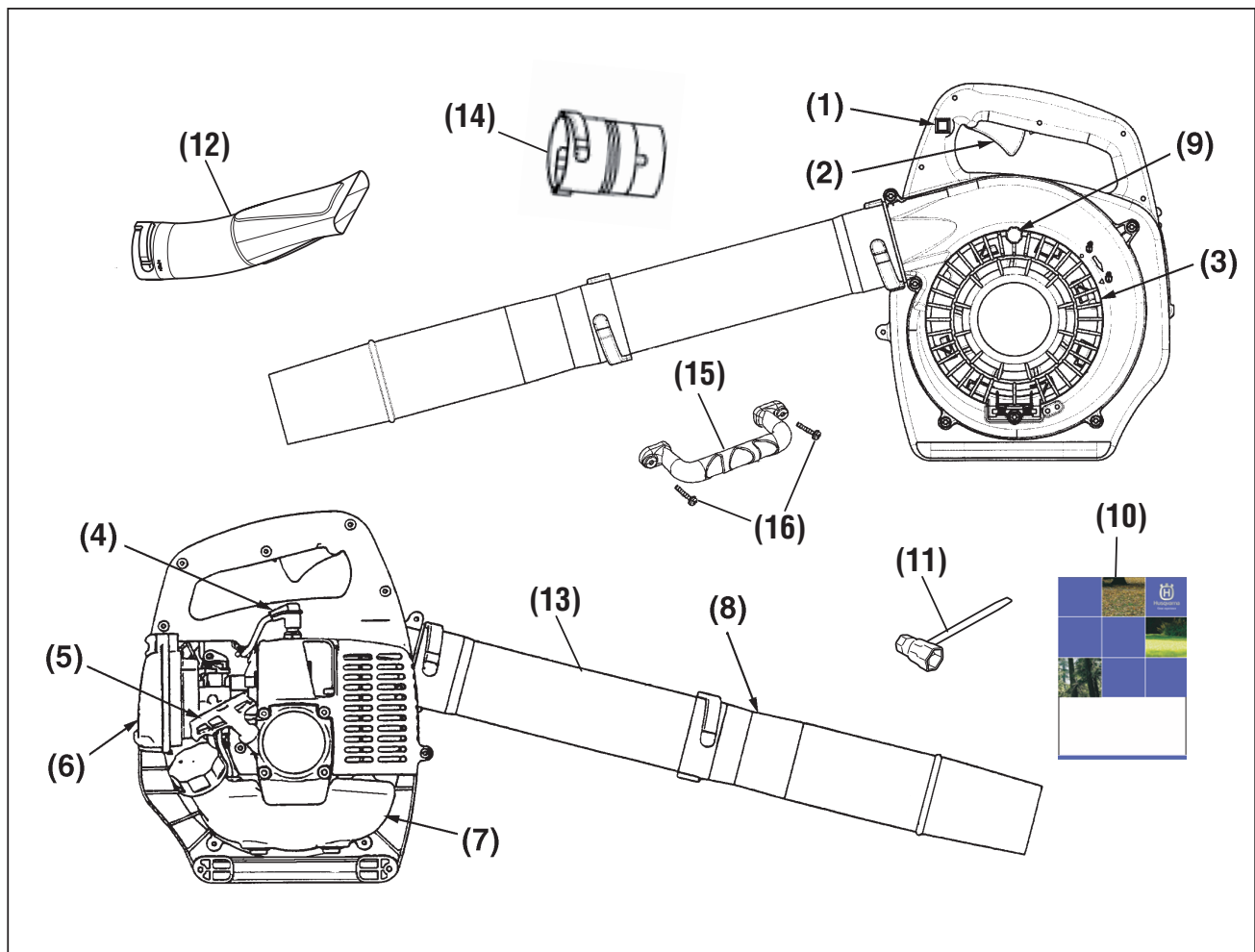

What is what on the blower?

- | | | | |
|---|-------------------|----|-------------------------------|
| 1 | Stop switch | 9 | Screw to the air inlet screen |
| 2 | Throttle trigger | 10 | Operator's manual |
| 3 | Air intake screen | 11 | Combination spanner |
| 4 | Spark plug | 12 | Flat nozzle |
| 5 | Starter handle | 13 | Intermediate pipe |
| 6 | Air filter | 14 | Extension pipe |
| 7 | Fuel tank | 15 | Support handle |
| 8 | Round nozzle | 16 | Screws |

GENERAL SAFETY PRECAUTIONS

General



WARNING! Prolonged use of a blower, exposing the operator to vibrations and cold may produce whitefinger disease (Raynaud's phenomenon), which symptoms are tingling and burning sensations followed by loss of color and numbness in the fingers. All factors which contribute to whitefinger disease are known, but cold weather, smoking diseases or physical conditions as well as long periods of exposure to vibration are mentioned as factors. In order to reduce the risk of whitefinger disease, the following precautions are strongly recommended.

Wear thick anti-vibration gloves.

Take more than 5 minutes of break in warm place frequently.

Maintain a firm grip at all times, but do not squeeze the handles with constant, excessive pressure.

If you feel discomfort, redness and swelling of your fingers or any other part of your body, see a doctor before getting worse.

IMPORTANT!

The machine is only designed for blowing lawns, pathways, asphalt roads and the like.

Carry out an overall inspection of the machine before use. See the maintenance schedule.

Never use the machine if you are tired, if you have drunk alcohol, or if you are taking medication that could affect your vision, your judgement or your co-ordination.

Wear personal protective equipment. See instructions under the "Personal protective equipment" heading.

Never use a machine that has been modified in any way from its original specification.

Never use a machine that is faulty. Carry out the checks, maintenance and service instructions described in this manual. Some maintenance and service measures must be carried out by trained and qualified specialists. See instructions under the Maintenance heading.

All covers and guards must be fitted before starting. Ensure that the spark plug cap and ignition lead are undamaged to avoid the risk of electric shock.

The blower operator must ensure that no people or animals come closer than 15 metres. When several operators are working at the same site a safety distance of at least 15 metres must be in effect.

Never allow children to use the machine.

Never allow anyone else to use the machine without first ensuring that they have understood the contents of the operator's manual.

Always check for any objects that may block the air intake screen before beginning work.

Always contact local authorities and make sure you are following applicable directives.

Keep all parts of your body away from hot surfaces. Metallic parts and engine cover reach high temperatures during operation and doing so could result in serious burns.

Never remove debris from the inlet screen while the engine is running. Contact with rotating blower fan result in a serious personal injury.



WARNING! This machine produces an electromagnetic field during operation. This field may under some circumstances interfere with active or passive medical implants. To reduce the risk of serious or fatal injury, we recommend persons with medical implants to consult their physician and the medical implant manufacturer before operating this machine.

GENERAL SAFETY PRECAUTIONS

Starting

- Never start the machine indoors. Exhaust fumes can be dangerous if inhaled.
- Observe the surroundings and ensure that no people or animals can come into contact with the blower.
- Place the machine on the ground, press the machine body against the ground with your left hand (NOTE! Not your foot). Now grasp the starter handle with your right hand and then pull quickly and firmly.

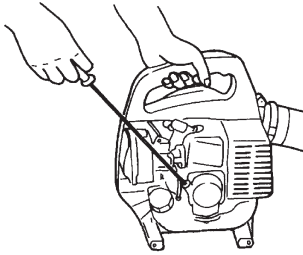

Fuel safety

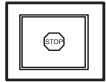

- Always use a fuel container with an anti-spill valve.
- Never refuel the machine while the engine is running. Always stop the engine and let it cool for a few minutes before refuelling.
- Make sure there is plenty of ventilation when refuelling or mixing fuel (petrol and 2-stroke oil).
- Avoid all skin contact with fuel. Fuel is a skin irritant and may even cause skin changes.
- Move the machine at least 3 m from the refuelling point before starting it.

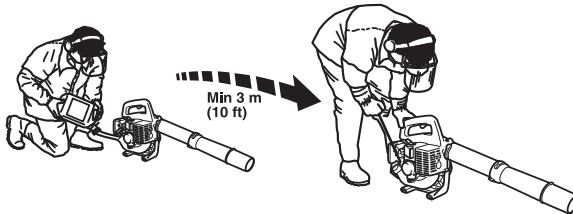

- Never start the machine:
 - If you have spilt fuel on it. Wipe off the spillage and allow remaining fuel to evaporate.
 - If you have spilt fuel on yourself or your clothes, change your clothes. Wash any part of your body that has come in contact with fuel. Use soap and water.
 - If the machine is leaking fuel. Check regularly for leaks from the fuel cap and fuel lines.

Transport and storage

- Store and transport the machine and fuel so that there is no risk of any leakage or fumes coming into contact with sparks or naked flames, for example, from electrical machinery, electric motors, electrical relays/switches or boilers.
- When storing and transporting fuel always use approved containers intended for this purpose.
- When storing the machine for long periods the fuel tank must be emptied. Contact your local petrol station to find out where to dispose of excess fuel. Empty the fuel tank and press the primer until all fuel has been emptied. Remove the spark plug and drop a spoon of 2-stroke oil in the cylinder. Turn over the engine a few times and then put the spark plug back in place.
- Ensure the machine is cleaned and that a complete service is carried out before long-term storage.
- Secure the machine during transport.
- Store the machine in a dry, cool, well-aired and dust-free location. Store the machine out of reach of children.



WARNING! Take care when handling fuel. Bear in mind the risk of fire, explosion and inhaling fumes.

SAFETY INSTRUCTIONS

Personal protective equipment



WARNING! You must use approved personal protective equipment whenever you use the machine. Personal protective equipment cannot eliminate the risk of injury but it will reduce the degree of injury if an accident does happen. Ask your dealer for help in choosing the right equipment. Please read the operator's manual carefully and make sure you understand the instructions before using the machine.



WARNING! Listen out for warning signals or shouts when you are wearing hearing protection. Always remove your hearing protection as soon as the engine stops.

- Gloves should be worn when necessary.

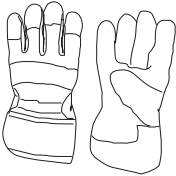

- Wear hearing protection that provides adequate noise reduction.

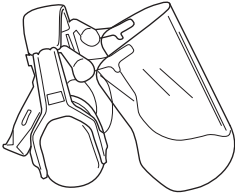

- Always wear approved eye protection. If you use a visor then you must also wear approved protective goggles. Approved protective goggles must comply with the ANSI Z87.1 standard in the USA or EN 166 in EU countries. Blows from branches or objects that are thrown can damage the eyes.

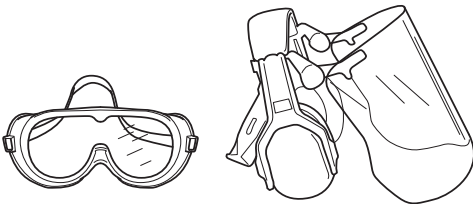

- Wear sturdy, non-slip boots.



- Wear clothes made of a strong fabric and avoid loose clothing that can catch on twigs and branches. Always wear heavy, long pants. Do not wear jewellery, shorts sandals or go barefoot. Secure hair so it is above shoulder level.
- A breathing mask should be used when there is a risk of dust.

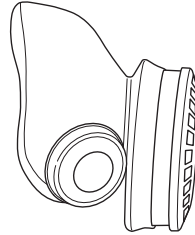

- Always have a first aid kit nearby.

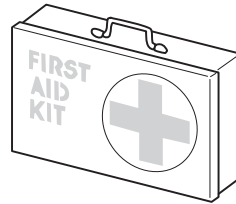

Machine's safety equipment

This section describes the machine's safety equipment, its purpose, and how checks and maintenance should be carried out to ensure that it operates correctly. See the "What is what?" section to locate where this equipment is positioned on your machine.



WARNING! Never use a machine that has faulty safety equipment! Carry out the inspection, maintenance and service routines listed in this section.

Stop switch

Use the stop switch to switch off the engine.

Remove the ignition cable and the spark plug to carry out inspection and maintenance.

Muffler

The muffler is designed to keep noise levels to a minimum and to direct exhaust fumes away from the user.

In countries that have a warm and dry climate there is a significant risk of fire. Consequently, we have equipped the muffler with a spark arrestor mesh mounted inside the muffler.

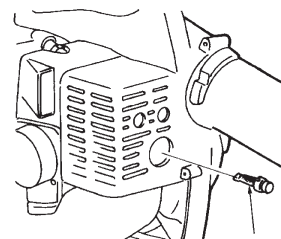

SAFETY INSTRUCTIONS

For mufflers it is very important that you follow the instructions on checking, maintaining and servicing your machine. See instructions under the heading Checking, maintaining and servicing the machine's safety equipment.



WARNING!

Bear in mind that: Engine exhaust fumes contain carbon monoxide, which can cause carbon monoxide poisoning. For this reason you should not start or run the machine indoors, or anywhere that is poorly ventilated.

The exhaust fumes from the engine are hot and may contain sparks which can start a fire. Never start the machine indoors or near combustible material!



WARNING! The inside of the muffler contain chemicals that may be carcinogenic. Avoid contact with these elements in the event of a damaged muffler.

Checking, maintaining and servicing the machine's safety equipment



WARNING! All servicing and repair work on the machine requires special training. This is especially true of the machine's safety equipment. If your machine fails any of the checks described below you must contact your service agent. When you buy any of our products we guarantee the availability of professional repairs and service. If the retailer who sells your machine is not a servicing dealer, ask him for the address of your nearest service agent.

- If you detect abnormal vibration or noise during operation, promptly stop the blower and check whether something has broken.
- If a breakdown has occurred, do not operate the blower until the problem is fixed.

Stop switch

- Start the engine and make sure the engine stops when you move the stop switch to the stop setting.

Move the throttle trigger to the idling position and press the stop switch (red button) until the engine comes to a complete stop.

Muffler



- Never use a machine that has a faulty muffler.

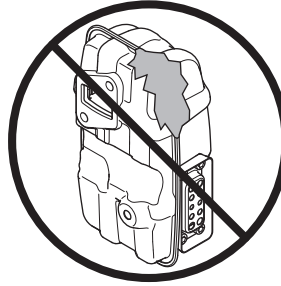

- Regularly check that the muffler is securely attached to the machine.
- The muffler on your machine is equipped with a spark arrestor mesh; this must be cleaned regularly. See the heading Muffler in the Maintenance chapter. A blocked mesh will cause the engine to overheat and may lead to serious damage. Never use a muffler with a defective spark arrestor mesh.



WARNING! Never use a machine with faulty safety equipment. The machine's safety equipment must be checked and maintained as described in this section. If your machine fails any of these checks contact your service agent to get it repaired.

Air filter

Never use the leaf blower without an air filter or with a damaged or deformed filter element as unfiltered, dusty air can quickly destroy the engine.

General working instructions

IMPORTANT! This section considers basic safety rules when working with blowers. If you encounter a situation where you are uncertain how to proceed you should ask an expert. Contact your dealer or your service workshop. Avoid all usage which you consider to be beyond your capability.

Show consideration to persons in your surroundings by avoiding using the machine at unsuitable times, such as late in the evening or early in the morning. Reduce the noise levels by limiting the number of equipment units used simultaneously. Read through and follow the simple directions so that you disturb your surroundings as little as possible.

- Use the blower with the lowest possible throttle. It is seldom necessary to use full throttle, and many work procedures can be done at half throttle. A lower throttle means less noise and less dust, and it is also easier to keep control over the rubbish collected together/moved.

SAFETY INSTRUCTIONS

- Use a rake or a brush to release rubbish stuck to the ground.
- Hold the opening of the blower as close to the ground as possible. Utilise the entire length of the blow pipe to keep the air current close to the ground.
- Clean up afterwards. Make sure that you have not blown rubbish into someone's garden.
- Use the machine during normal working hours to avoid unnecessary noise. Avoid working early in the morning or late at night.



WARNING! Be aware of your surroundings. If anyone approaches your work area, set the throttle control to the lowest throttle until the person is at a safe distance. Direct the blower away from people, animals, play areas, open windows and cars etc.

Basic safety rules



- No unauthorised persons or animals may be present in the working area, which is 15 metres.
- Allow the engine to cool before refuelling.
- Keep all parts of your body away from hot surfaces.
- Never touch the spark plug or ignition cable while the engine is running. Touching the spark plug or plug may result in being subjected to an electrical shock.
- The powerful currents of air can move objects at such a speed that they can bounce back and cause serious eye injuries.
- Do not direct the air jet towards people or animals.
- Stop the engine before assembling or dismantling accessories or other parts.
- Limit the amount of time over which the product is to be used continuously to somewhere around 30 - 40 minutes per session. Also try to keep the total amount of work performed in a single day under 2 hours or less.
- Do not use the machine in bad weather, such as dense fog, heavy rain, strong wind, intense cold, etc. Working in bad weather is tiring and can lead to dangerous conditions, e.g. slippery surfaces.
- Minimise the blowing time by lightly wetting dusty areas or using spray equipment.
- Reduce water consumption by using blowers instead of water hoses for different applications around the lawn and garden, such as lattices, screens, grills, porches, etc
- Make sure you can move and stand safely. Check the area around you for possible obstacles (roots, rocks, branches, ditches, etc.) in case you have to move suddenly. Take great care when working on sloping ground.

- Never put the machine down with the engine running unless you have it in clear sight.
- Engine exhaust fumes contain carbon monoxide, which can cause carbon monoxide poisoning. For this reason you should not start or run the machine indoors, or anywhere that is poorly ventilated.
- The blower must not be used while on a ladder or scaffolding.
- CAUTION! Do not use the machine unless you are able to call for help in the event of an accident.

Basic working techniques



WARNING! Watch out for thrown objects. Always wear eye protection. Stones, rubbish, etc. can be thrown up into the eyes causing blindness or serious injury. Keep unauthorised persons at a distance. Children, animals, onlookers and helpers should be kept outside the safety zone of 15 m. Stop the machine immediately if anyone approaches.



WARNING! Always stop the engine before cleaning.

- The speed of the air jet is regulated by means of the throttle. Select the speed best suited for respective tasks.
- You can set the throttle position using the "stop switch" and by doing so not need to hold your finger on the throttle all the time you are using the blower. Full throttle is obtained when the control is held back fully.
- Check that the air intake is not blocked, for example, by leaves or rubbish. A clogged air intake reduces the machine's blowing capacity and increases the engine's working temperature, which can result in engine failure. Stop the engine and remove the object.
 - Be aware of the wind direction. Work with the wind to make your work easier.
 - Use the full blower nozzle extension so the air stream can work close to the ground.
 - Always check to be sure that no debris has been blown onto someone else's property.
 - Never point a blower tube toward an open flame to avoid the possibility of igniting the unit, causing injury to yourself or damage to surroundings.
 - Using the blower to move large piles is time consuming and creates unnecessary noise.
 - Keep a good balance and a firm foothold.
 - When work is finished the machine should be stored vertically.

ASSEMBLY

Blow pipe

- Align groove in blower pipe with projection on blower housing (or another blower pipe) and slide the pipe onto the blower housing (or another blower pipe). Rotate the pipe clockwise to lock it into place.

Round nozzle

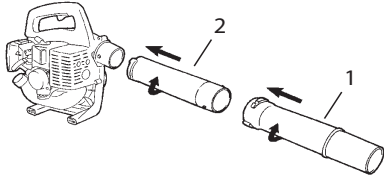

- 1 Round nozzle
- 2 Intermediate pipe
- 3 Flat nozzle
- 4 Extension pipe

Flat nozzle

When using a flat nozzle, please use a extension pipe as needed.

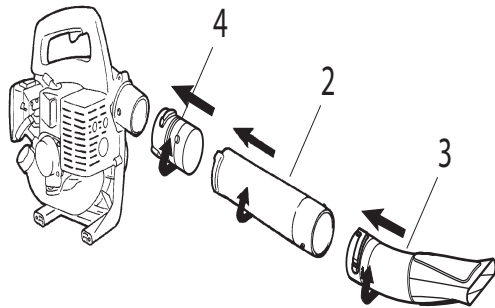

Installing support handle

- This handle is supplied with the blower.

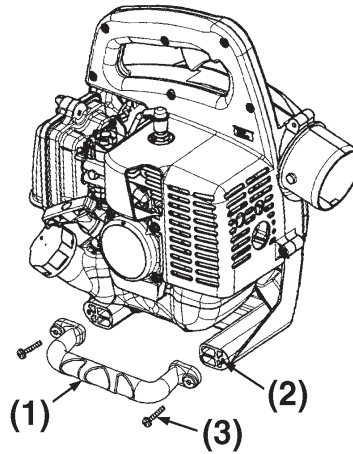

- Fit the holes (2) of volute and handle (1), tighten the screws (3).
- Be sure to tighten the screws straightly.

FUEL HANDLING

Fuel

CAUTION! The machine is equipped with a two-stroke engine and must always be run using a mixture of petrol and two-stroke oil. It is important to accurately measure the amount of oil to be mixed to ensure that the correct mixture is obtained. When mixing small amounts of fuel, even small inaccuracies can drastically affect the ratio of the mixture.



WARNING! Always ensure there is adequate ventilation when handling fuel.

Petrol

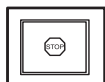

CAUTION! Always use a good quality petrol/oil mixture (at least 90 octane).



- The lowest recommended octane rating is 90. If you run the engine on a petrol with a lower octane rating than 90 this can cause knocking. This leads to an increased engine temperature, which can result in serious engine damage.
- When working at continuous high revs a higher octane rating is recommended. Use good quality unleaded petrol.

Ethanol blended fuel, E10 may be used (max 10% ethanol blend). Using ethanol blends higher than E10 will create lean running condition which can cause engine damage.

Two-stroke oil

- For best results and performance use HUSQVARNA two-stroke oil, which is specially formulated for our two-stroke engines. Mixture 1:50 (2%).
- If HUSQVARNA two-stroke oil is not available, you may use another two-stroke oil of good quality that is intended for air cooled engines. Contact your dealer when selecting an oil. Mixing ratio 1:33 (3%).
- Never use two-stroke oil intended for water-cooled outboard engines, sometimes referred to as outboard oil.
- Never use oil intended for four-stroke engines.

Petrol, litre	Two-stroke oil, litre	
	2% (1:50)	3% (1:33)
5	0,10	0,15
10	0,20	0,30
15	0,30	0,45
20	0,40	0,60

Mixing

- Always mix the petrol and oil in a clean container intended for fuel.
- Always start by filling half the amount of the petrol to be used. Then add the entire amount of oil. Mix (shake) the fuel mixture. Add the remaining amount of petrol.
- Mix (shake) the fuel mixture thoroughly before filling the machine's fuel tank.



- Do not mix more than one month's supply of fuel at a time.
- If the machine is not used for some time the fuel tank should be emptied and cleaned.

FUEL HANDLING

Fueling

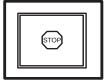

WARNING! Taking the following precautions, will lessen the risk of fire:

Refuel in a well ventilated area. Never fuel the machine indoors.

Do not smoke or place hot objects near fuel.

Always shut off the engine before refuelling.

Always stop the engine and let it cool for a few minutes before refuelling.

When refuelling, open the fuel cap slowly so that any excess pressure is released gently.

Tighten the fuel cap carefully after refuelling.

If you have spilt fuel on it. Wipe off the spillage and allow remaining fuel to evaporate.

Always move the machine away from the refuelling area and source before starting.

- Move the machine at least 3 m from the refuelling point before starting it.

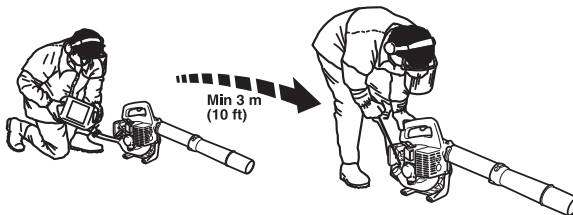

- Clean the area around the fuel cap. Contamination in the tank can cause operating problems.
- Ensure that the fuel is well mixed by shaking the container before filling the tank.
- Check the fuel level before each use and leave space for the fuel to expand, because the heat from the engine and the sun may otherwise cause the fuel to expand and overflow.
- Keep the handle dry and free from oil and fuel.
- Always store fuel in an approved container designed for that purpose.

STARTING AND STOPPING

Starting and stopping



WARNING! Always move the machine away from the refuelling area and source before starting. Place the machine on a flat surface.

Make sure no unauthorised persons are in the working area. Otherwise there is a risk of serious personal injury. The safety distance is 15 metres.

The machine may only be started in its complete design. If the machine is started without all the guards fitted there is a risk of personal injuries.

Starting engine

Pump the primer until fuel flows out in the clear tube.

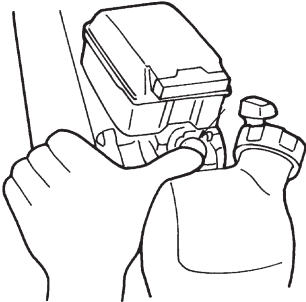

Move the choke lever upward to choke position.

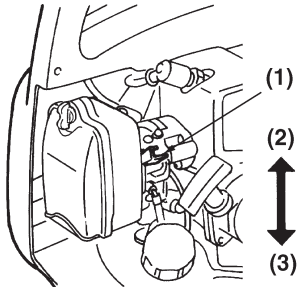

- 1 Choke lever
- 2 Choke lever in "closed position".
- 3 Choke lever in "open position".

Holding the blower handle, pull the starter rope with your right hand. (throttle trigger in idling position).

NOTE!

Do not pull the starter cord all the way out and do not let go of the starter handle when the cord is fully extended. This can damage the machine.

After the engine starts, slowly open the choke. Allow the engine to warm for a few minutes.

Warm engine

Use the same starting procedure as for a cold engine but without setting the choke control in the choke position. If the engine won't start after several attempts, close the choke and repeat pulling the rope or remove the spark plug and dry it.

Stop switch

Move the throttle trigger to the idling position and press the stop switch (red button) until the engine comes to a complete stop.

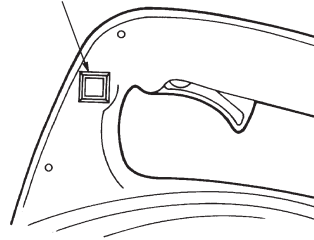

IMPORTANT! Except for an emergency, avoid stopping the engine while pulling the throttle trigger.

MAINTENANCE

General

Remove the ignition cable and the spark plug to carry out inspection and maintenance. Keep all parts of your body away from hot surfaces.

Carburettor

Adjustment of the idle speed

Before any adjustments are made, make sure that the air filter is clean and the air filter cover is fitted.

When the engine tends to stop frequently at an idle mode, turn the adjusting screw clockwise.

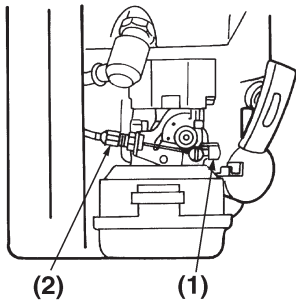

- 1 Adjusting the idle speed
- 2 Cable adjustment

IMPORTANT! warm up the engine before adjusting the idle speed.

Muffler

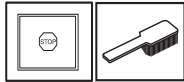

The muffler is designed to reduce the noise level and to direct the exhaust gases away from the operator. The exhaust gases are hot and can contain sparks, which may cause fire if directed against dry and combustible material.

The muffler is equipped with a special spark arrester mesh. The spark arrester mesh should be cleaned once a month. This is best done with a wire brush.

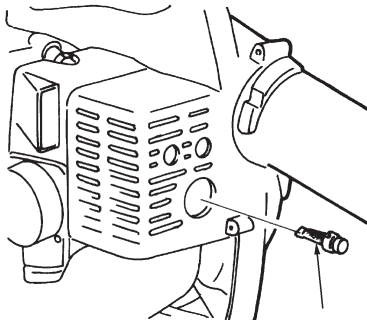

CAUTION! Never use a machine with a defective muffler. Check regularly that the muffler is complete and secured correctly. Tightening torque 7 - 10 Nm



WARNING! The muffler gets very hot during use and remain so for some time after stopping. This also applies at idle speed. Contact can result in burns to the skin. Remember the risk of fire!

Clean the muffler.

- After every 50 hours of use the muffler must be cleaned.
- Remove the muffler, insert a screwdriver into the vent, and wipe away any carbon buildup. Wipe away any carbon buildup on the muffler exhaust vent and cylinder exhaust vent at the same time.

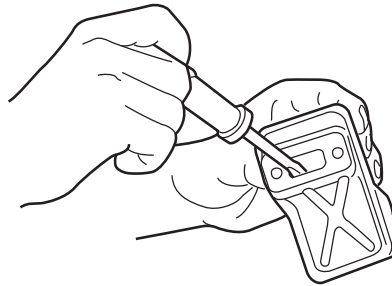

- Make sure all nuts and bolts are tightened correctly.

Cooling system

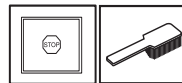

To keep the working temperature as low as possible the machine is equipped with a cooling system.

The cooling system consists of:

- Cooling fins on the cylinder.
- Air intake screen

Clean the cooling system with a brush once a week, more often in demanding conditions. A dirty or blocked cooling system results in the machine overheating which causes damage to the piston and cylinder. Check that the nozzles are not blocked.

MAINTENANCE

Air intake screen

Check that the air intake is not blocked on all sides including the underside, for example, by leaves or rubbish. A clogged air intake reduces the machine's blowing capacity and increases the engine's working temperature, which can result in engine failure. Stop the engine and remove the object.

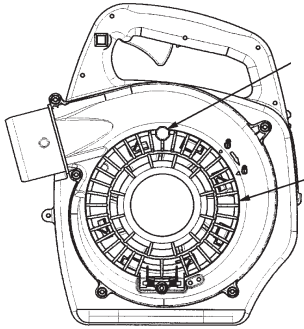

WARNING! Never use the blower if the screen is not in place. Before use, check that the screen is in place and undamaged.

Spark plug

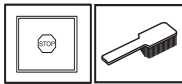

The spark plug condition is influenced by:

- Incorrect carburettor adjustment.
- An incorrect fuel mixture (too much or incorrect type of oil).
- A dirty air filter.

These factors cause deposits on the spark plug electrodes, which may result in operating problems and starting difficulties.

Clean the outside of the spark plug. Remove it and check the electrode gap. Adjust the gap to 0,6-0,7 mm or replace the spark plug. Check that the spark plug is fitted with a suppressor.

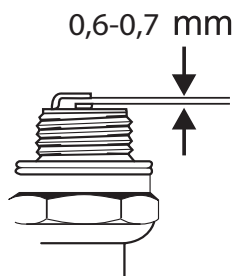

CAUTION! Always use the recommended spark plug type! Use of the wrong spark plug can damage the piston/cylinder. Replace the plug twice a year.

Air filter

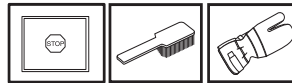

The air filter must be regularly cleaned to remove dust and dirt in order to avoid:

- Carburettor malfunctions
- Starting problems
- Loss of engine power
- Unnecessary wear to engine parts.
- Excessive fuel consumption.

Check the air cleaner every 25 hours of use or more frequently if used under dusty conditions.

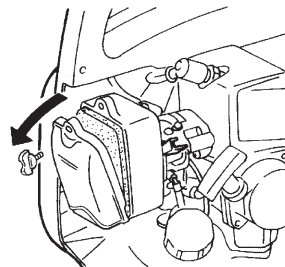

Avoid contact with hot surfaces on muffler, cylinder etc. Contact can result in burns to the skin.

Cleaning the air filter

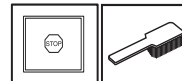

- 1 Remove the air filter cover and air filter.
- 2 Use neutral detergent and warm water to clean the filter element. Ensure that the filter is dry before refitting it. (1)
- 3 Install the air filter.

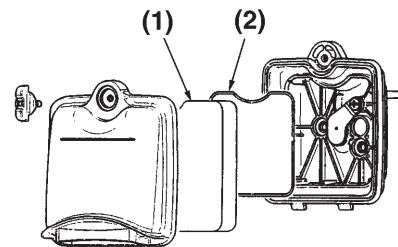

- 4 Never forget to attach the screen. If the screen is not attached, the cleaner will not seal properly and the dusts come into the cylinder. (2)

An air filter that has been in use for a long time cannot be cleaned completely. The filter must therefore be replaced with a new one at regular intervals. **A damaged air filter must always be replaced.**

- Refit the air filter and air filter cover.

Fuel filter

Check the fuel filter from contamination and the fuel hose from cracks or other defects. Replace if necessary.

The fuel filter sits inside the fuel tank. The filter can be taken out of the fueling port using a small wire hook. Disconnect the filter assembly from the fuel pipe and unhook the retainer to disassemble it. Clean the components with gasoline.

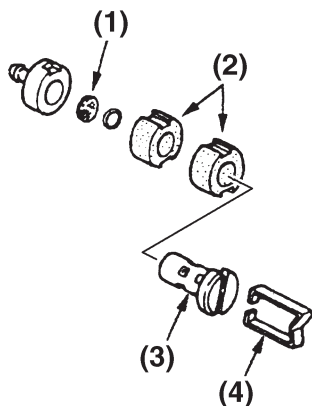

- 1 Screen
- 2 Element
- 3 Holder
- 4 Retainer

MAINTENANCE

Maintenance schedule

Below you will find some general maintenance instructions. If you need further information please contact your service workshop.

Maintenance	Daily maintenance	Weekly maintenance	Monthly maintenance
Clean the outside of the machine.	X		
Check that the throttle control functions safely.	X		
Check that the stop switch works correctly.	X		
Clean the air filter. Replace if necessary.	X		
Check that nuts and screws are tight.	X		
Check that there are no fuel leaks from the engine, tank or fuel lines.	X		
Check the fuel filter from contamination and the fuel hose from cracks or other defects. Replace if necessary.	X		
Clean or replace the spark arrestor mesh on the muffler (only applies to mufflers without a catalytic converter).	X		
Check that all sides of the air intake screen are not blocked.	X		
Check the starter and starter cord.		X	
Check that the vibration damping elements are not damaged.		X	
Clean the outside of the spark plug. Remove it and check the electrode gap. Adjust the gap to 0,6-0,7 mm or replace the spark plug. Check that the spark plug is fitted with a suppressor.		X	
Clean the machine's cooling system.		X	
Clean the outside of the carburettor and the space around it.		X	
Check all cables and connections.			X
Replace the spark plug. Check that the spark plug is fitted with a suppressor.			X
Check and clean the spark arrestor mesh on the muffler (only applies to mufflers fitted with a catalytic converter).			X
Clean the fuel tank.			X

TECHNICAL DATA

Technical data

Technical data	425 BVS
Engine	
Cylinder displacement, cm ³	25.4
Idle speed, rpm	2800
Max. engine output, acc. to ISO 8893, kW/ rpm	
Catalytic converter muffler	No
Speed-regulated ignition system	No
Ignition system	
Spark plug	NGK CMR7H
Electrode gap, mm	0,6-0,7
Fuel and lubrication system	
Fuel tank capacity, litre	0.65
Weight	
Weight without fuel, kg	4.2
Noise emissions	
(see note 1)	
Sound power level, measured dB (A)	103
Sound power level, guaranteed L _{WA} dB (A)	106
Noise levels	
(see note 2)	
Equivalent sound pressure level at the operator's ear, measured according to EN15503 dB(A)	90
Vibration levels	
(see note 3)	
Equivalent vibration levels (a _{hv,eq}) at handles, measured according to EN15503, m/s ²	13.0
Fan performance	
Max. air velocity with round nozzle, m/s:	66.9
Air flow with standard nozzle, m ³ /min (ANSI)	11.4

Note 1: Noise emissions in the environment measured as sound power (L_{WA}) in conformity with EC directive 2000/14/EC. Reported sound power level for the machine has been measured with the original cutting attachment that gives the highest level. The difference between guaranteed and measured sound power is that the guaranteed sound power also includes dispersion in the measurement result and the variations between different machines of the same model according to Directive 2000/14/EC.

Note 2: The equivalent sound pressure level value is calculated with a work cycle of a duration of 1/7 for idling and 6/7 for racing. Reported data for equivalent sound pressure level for the machine has a typical statistical dispersion (standard deviation) of 1 dB(A).

Note 3: The equivalent vibration level value is calculated with a work cycle of a duration of 1/7 for idling and 6/7 for racing. Reported data for equivalent vibration level has a typical statistical dispersion (standard deviation) of 1 m/s².

Original instructions

1154859-26



2012-09-07