

STIHL®

STIHL HS 45

Instruction Manual
Manual de instrucciones



! WARNING

Read Instruction Manual thoroughly before use and follow all safety precautions – improper use can cause serious or fatal injury.

! ADVERTENCIA

Antes de usar la máquina lea y siga todas las precauciones de seguridad dadas en el manual de instrucciones – el uso incorrecto puede causar lesiones graves o mortales.



Instruction Manual

1 - 32

Manual de instrucciones

33 - 68

Contents

Guide to Using this Manual	2
Safety Precautions and Working Techniques	3
Using the Unit	11
Fuel	12
Fueling	13
Starting / Stopping the Engine	14
Operating Instructions	15
Cleaning the Air Filter	16
Engine Management	16
Adjusting the Carburetor	17
Spark Plug	18
Engine Running Behavior	19
Lubricating the Gearbox	19
Rewind Starter	20
Storing the Machine	20
Sharpening Instructions	20
Inspections and Maintenance by Dealer	21
Maintenance and Care	22
Main Parts	24
Specifications	25
Maintenance and Repairs	26
Disposal	26
STIHL Incorporated Federal Emission Control Warranty Statement	27
STIHL Incorporated California Exhaust and Evaporative Emissions Control Warranty Statement	29
Trademarks	31

Allow only persons who fully understand this manual to operate your hedge trimmer.

To receive maximum performance and satisfaction from your STIHL hedge trimmer, it is important that you read, understand and follow the safety precautions and the operating and maintenance instructions in chapter "Safety Precautions and Working Techniques" before using your hedge trimmer. For further information you can go to www.stihlusa.com.

Contact your STIHL dealer or the STIHL distributor for your area if you do not understand any of the instructions in this manual.

WARNING

Because a hedge trimmer is a high-speed cutting tool some special safety precautions must be observed to reduce the risk of personal injury. Careless or improper use may cause serious or even fatal injury.

STIHL®

This instruction manual is protected by copyright. All rights reserved, especially the rights to reproduce, translate and process with electronic systems.

Guide to Using this Manual

Pictograms

The meanings of the pictograms attached to or embossed on the machine are explained in this manual.

Depending on the model concerned, the following pictograms may be on your machine.



Fuel tank for gasoline and engine oil mixture

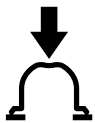

Press to operate manual fuel pump

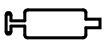

Filler hole for gear lubricant



Starting lock



Rotating rear handle

Symbols in Text

Many operating and safety instructions are supported by illustrations.

The individual steps or procedures described in the manual may be marked in different ways:

- A bullet marks a step or procedure.

A description of a step or procedure that refers directly to an illustration may contain item numbers that appear in the illustration. Example:

- Loosen the screw (1).
- Lever (2) ...

In addition to the operating instructions, this manual may contain paragraphs that require your special attention. Such paragraphs are marked with the symbols and signal words described below:



DANGER

Indicates an imminent risk of severe or fatal injury.



WARNING

Indicates a hazardous situation which, if not avoided, could result in severe or fatal injury.

NOTICE

Indicates a risk of property damage, including damage to the machine or its individual components.

Engineering Improvements

STIHL's philosophy is to continually improve all of its products. As a result, engineering changes and improvements are made from time to time. Therefore, some changes, modifications and improvements may not be covered in this manual. If the operating characteristics or the appearance of your machine differs from those

described in this manual, please contact your STIHL dealer or the STIHL distributor for your area for assistance.

Safety Precautions and Working Techniques



Because a hedge trimmer is a high-speed, fast-cutting power tool with sharp cutting blades, special safety precautions must be observed to reduce the risk of personal injury.



It is important that you read, fully understand and observe the following safety precautions and warnings. Read the instruction manual and the safety precautions periodically. Careless or improper use may cause serious or fatal injury.

Have your STIHL dealer show you how to operate your power tool. Observe all applicable local safety regulations, standards and ordinances.



WARNING
Do not lend or rent your power tool without the instruction manual. Be sure that anyone using it understands the information contained in this manual.



WARNING
The use of this machine may be hazardous. If the cutting tool comes in contact with your body, it will cut you.

Use your hedge trimmer only for cutting hedges, shrubs, scrub, bushes and similar material.



WARNING
Do not use it for other purposes, since misuse may result in personal injury or property damage, including damage to the machine.



WARNING
Minors should never be allowed to use this power tool. Bystanders, especially children, and animals should not be allowed in the area where it is in use.



WARNING
To reduce the risk of injury to bystanders and damage to property, never let your power tool run unattended. When it is not in use (e.g. during a work break), shut it off and make sure that unauthorized persons do not use it.

Most of these safety precautions and warnings apply to the use of all STIHL hedge trimmers. Different models may have different parts and controls. See the appropriate section of your instruction manual for a description of the controls and the function of the parts of your model.

Safe use of a hedge trimmer involves

1. the operator
2. the power tool
3. the use of the power tool.

THE OPERATOR

Physical Condition

You must be in good physical condition and mental health and not under the influence of any substance (drugs, alcohol, etc.) which might impair vision, dexterity or judgment. Do not operate this machine when you are fatigued.



WARNING
Be alert – if you get tired, take a break. Tiredness may result in loss of control. Working with any power tool can be strenuous. If you have any condition that might be aggravated by strenuous work, check with your doctor before operating this machine.



WARNING
Prolonged use of a power tool (or other machines) exposing the operator to vibrations may produce whitefinger disease (Raynaud's phenomenon) or carpal tunnel syndrome.

These conditions reduce the hand's ability to feel and regulate temperature, produce numbness and burning sensations and may cause nerve and circulation damage and tissue necrosis.

All factors which contribute to whitefinger disease are not known, but cold weather, smoking and diseases or physical conditions that affect blood vessels and blood transport, as well as high vibration levels and long periods of

exposure to vibration are mentioned as factors in the development of whitefinger disease. In order to reduce the risk of whitefinger disease and carpal tunnel syndrome, please note the following:

- Most STIHL power tools are available with an anti-vibration ("AV") system designed to reduce the transmission of vibrations created by the machine to the operator's hands. An AV system is recommended for those persons using power tools on a regular or sustained basis.
- Wear gloves and keep your hands warm.
- Keep the AV system well maintained. A power tool with loose components or with damaged or worn AV elements will tend to have higher vibration levels.
- Maintain a firm grip at all times, but do not squeeze the handles with constant, excessive pressure. Take frequent breaks.

All the above-mentioned precautions do not guarantee that you will not sustain whitefinger disease or carpal tunnel syndrome. Therefore, continual and regular users should closely monitor the condition of their hands and fingers. If any of the above symptoms appear, seek medical advice immediately.

WARNING

The ignition system of the STIHL unit produces an electromagnetic field of a very low intensity. This field may interfere with some pacemakers. To reduce the risk of serious or fatal injury, persons with a pacemaker should

consult their physician and the pacemaker manufacturer before operating this tool.

Proper Clothing

WARNING

To reduce the risk of injury, the operator should wear proper protective apparel.

WARNING



To reduce the risk of injury to your eyes never operate your power tool unless wearing goggles or properly fitted protective glasses with adequate top and side protection complying with ANSI Z87 "+" (or your applicable national standard.) To reduce the risk of injury to your face STIHL recommends that you also wear a face shield or face screen over your goggles or protective glasses.

Power tool noise may damage your hearing. Wear sound barriers (ear plugs or ear muffers) to protect your hearing. Continual and regular users should have their hearing checked regularly.

Be particularly alert and cautious when wearing hearing protection because your ability to hear warnings (shouts, alarms, etc.) is restricted.



Always wear heavy duty work gloves (e.g. made of leather or other wear resistant material) when handling the machine and the cutting tool. Heavy-duty, nonslip gloves improve your grip and help to protect your hands.



Clothing must be sturdy and snug-fitting, but allow complete freedom of movement. Wear long pants made of heavy material to help protect your legs. Do not wear shorts, sandals or go barefoot.

Avoid loose-fitting jackets, scarfs, neckties, jewelry, flared or cuffed pants, unconfined long hair or anything that could become caught on branches, brush or the moving parts of the unit. Secure hair so it is above shoulder level.



Good footing is very important. Wear sturdy boots with nonslip soles. Steel-toed safety boots are recommended.

THE POWER TOOL

For illustrations and definitions of the power tool parts see the chapter on "Main Parts".

WARNING

Never modify this power tool in any way. Only attachments supplied by STIHL or expressly approved by STIHL for use

with the specific STIHL model are authorized. Although certain unauthorized attachments are useable with STIHL power tools, their use may, in fact, be extremely dangerous.

If this tool is subjected to unusually high loads for which it was not designed (e.g. heavy impact or a fall), always check that it is in good condition before continuing work. Check in particular that the fuel system is tight (no leaks) and that the controls and safety devices are working properly. Do not continue operating this machine if it is damaged. In case of doubt, have it checked by your STIHL servicing dealer.

THE USE OF THE POWER TOOL

Transporting the Power Tool

WARNING

To reduce the risk of injury from blade contact, never carry or transport your power tool with the cutter blades moving.

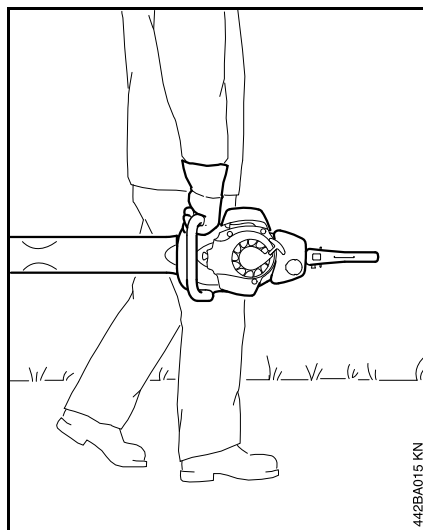

It may be carried only in the horizontal position. Grip the front handle and keep the hot muffler away from your body and the cutter blades behind you.

WARNING

Always switch off the engine and fit the scabbard over the cutter blades before transporting the power tool over long distances. When transporting it in a vehicle, properly secure it to prevent turnover, fuel spillage and damage to the unit.

Fuel

Your STIHL power tool uses an oil-gasoline mixture for fuel (see the chapter on "Fuel" of your instruction manual.)

WARNING



Gasoline is an extremely flammable fuel. If spilled and ignited by a spark or other ignition source, it can cause fire and serious burn injury or property damage. Use extreme caution when handling gasoline or fuel mix. Do not smoke or bring any fire or flame near the fuel or the power tool. Note that combustible fuel vapor may escape from the fuel system.

Fueling Instructions

WARNING

Fuel your power tool in well-ventilated areas, outdoors. Always shut off the engine and allow it to cool before refueling. Gasoline vapor pressure may build up inside the fuel tank depending on the fuel used, the weather conditions and the tank venting system.

In order to reduce the risk of burns and other personal injury from escaping gas vapor and fumes, remove the fuel filler cap on your power tool carefully so as to allow any pressure build-up in the tank to release slowly. Never remove the fuel filler cap while the engine is running.

Select bare ground for fueling and move at least 10 feet (3 m) from the fueling spot before starting the engine. Wipe off any spilled fuel before starting your machine.

! WARNING



Check for fuel leakage while refueling and during operation. If fuel leakage is found, do not start or run the engine until the leak is fixed and any spilled fuel has been wiped away. Take care not to get fuel on your clothing. If this happens, change your clothing immediately.

! WARNING

In order to reduce the risk of fuel spillage and fire from an improperly tightened fuel cap, correctly position and tighten the fuel cap in the fuel tank opening.

Different models may be equipped with different fuel caps.

Toolless cap with grip

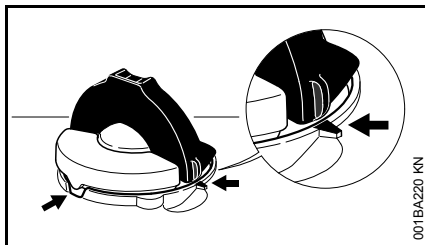

To do this with this STIHL cap, raise the grip on the top of the cap until it is upright at a 90° angle. Insert the cap in the fuel tank opening with the raised positioning marks on the grip of the cap and on the fuel tank opening lining up. Using the grip, press the cap down firmly while turning it clockwise as far as it will go (approx. 1/4 turn).



Fold the grip flush with the top of the cap. Grip the cap and check for tightness. If the grip does not lie completely flush with the cap and the detent on the grip does not fit in the corresponding recess in the filler opening, or if the cap is loose in the filler opening, the cap is not properly seated and tightened and you must repeat the above steps.

Misaligned, damaged or broken cap

- If the cap does not drop fully into the opening when the positioning marks line up and/or if the cap does not tighten properly when twisted, the base of the cap may be prematurely rotated (in relation to the top) to the closed position. Such misalignment can result from handling, cleaning or an improper attempt at tightening.

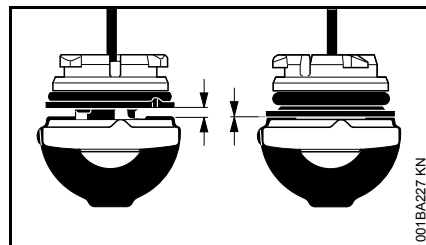

Left: Base of cap in closed position (with open space)

Right: Base of cap correctly positioned for installation

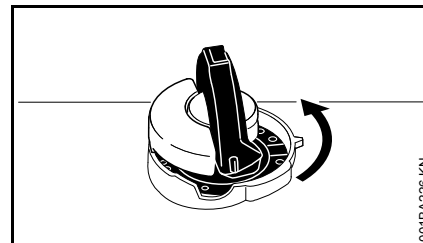

- To return the cap to the open position for installation, turn the cap (with the grip up) until it drops fully into the tank opening. Next, twist the cap counterclockwise as far as it will go (approx. 1/4 turn) – this will twist the base of the cap into the correct position. Then, twist the cap clockwise, closing it normally.
- If your cap still does not tighten properly, it may be damaged or broken; immediately stop use of the unit and take it to your authorized STIHL dealer for repair.

Screw Cap

! WARNING



Unit vibrations can cause an improperly tightened fuel filler cap to loosen or come off and spill quantities of fuel. In order to reduce the risk of fuel spillage and fire, tighten the fuel filler cap by hand as securely as possible.

See also the "Fueling" chapter in your Instruction Manual for additional information.

Before Starting**! WARNING**

Always check your power tool for proper condition and operation before starting, particularly the throttle trigger, throttle trigger lockout, stop switch and cutting tool. The throttle trigger (if applicable) must move freely and always spring back to the idle position. Never attempt to modify the controls or safety devices.

! WARNING

Check fuel system for leaks, especially the visible parts, e.g., filler cap, hose connections, manual fuel pump (only for power tools equipped with a manual fuel pump). Do not start the engine if there are leaks or damage – risk of fire! Have the machine repaired by a servicing dealer before using it.

! WARNING

Never use a power tool that is damaged or not properly maintained.

! WARNING

Check that the spark plug boot is securely mounted on the spark plug – a loose boot may cause arcing that could ignite combustible fumes and cause a fire.

Keep the handles clean and dry at all times; it is particularly important to keep them free of moisture, pitch, oil, fuel mix, grease or resin in order for you to maintain a firm grip and properly control your power tool.

! WARNING

The cutting tool must be properly tightened and in safe operating condition. Inspect for loose parts (nuts, screws, etc.) and for cracked, bent, warped or damaged blades. Regularly check the condition and tightness of the cutter blades – with the engine stopped! Replace damaged cutter blades before using the power tool. Always keep blades sharp.

STIHL recommends that you always spray the cutter blades with STIHL resin solvent before starting work – with the engine stopped! You can obtain this protective spray from your dealer. Apply generously.

Starting

Start the engine at least 10 feet (3 m) from the fueling spot, outdoors only.

For specific starting instructions, see the appropriate section of your manual. Place the power tool on firm ground or other solid surface in an open area. Maintain good balance and secure footing.

! WARNING

To reduce the risk of injury from blade contact, be absolutely sure that the cutting tool is clear of you and all other obstructions and objects, including the ground, because when the engine starts at starting-throttle, engine speed will be fast enough for the clutch to engage and move the blades on the cutting tool.

Once the engine has started, immediately blip the throttle trigger, which should release the starting throttle and allow the engine to slow down to idle.

! WARNING

Your power tool is a one-person machine. Do not allow other persons in the general work area, even when starting.

! WARNING

To reduce the risk of injury from loss of control, do not attempt to "drop start" your power tool.

! WARNING

When you pull the starter grip, do not wrap the starter rope around your hand. Do not let the grip snap back, but guide the starter rope to rewind it properly. Failure to follow this procedure may result in injury to your hand or fingers and may damage the starter mechanism.

Important Adjustments**! WARNING**

To reduce the risk of personal injury from loss of control or contact with the running cutting tool, do not use your unit with incorrect idle adjustment. At correct idle speed, the cutting tool should not move. For directions on how to adjust idle speed, see the appropriate section of your instruction manual.

If you cannot set the correct idle speed, have your STIHL dealer check your power tool and make proper adjustments and repairs.

During Operation

Holding and Controlling the Power Tool

Always hold the unit firmly with both hands on the handles while you are working. Wrap your fingers and thumbs around the handles.

Right-hand Use

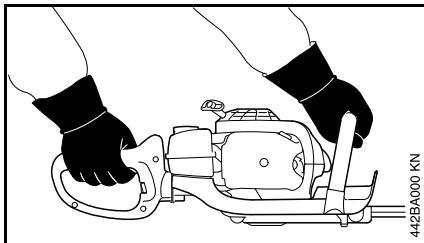

Put your right hand on the rear handle, left hand on the front handle.

Operate the machine so that the cutting blades are always away from your body.

Left-hand Use

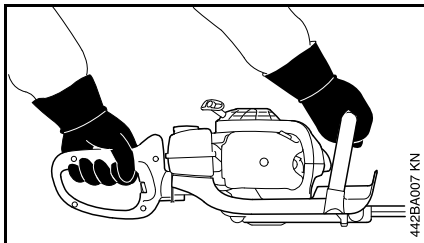

Put your left hand on the rear handle, right hand on the front handle.

! WARNING



Never attempt to operate your power tool with one hand. Loss of control of the power tool resulting in serious or fatal injury may result. To reduce the risk of cut injuries, keep hands and feet away from the cutting tool. Never touch a moving cutting tool with your hand or any other part of your body.

! WARNING

Do not overreach. Keep proper footing and balance at all times. Special care must be taken in slippery conditions (wet ground, snow) and in difficult, overgrown terrain. Watch for hidden obstacles such as tree stumps, roots and ditches to avoid stumbling. For better footing, clear away fallen branches, scrub and cuttings. Be extremely cautious when working on slopes or uneven ground.

! WARNING

To reduce the risk of injury from loss of control, never work on a ladder, in a tree or any other insecure support. Never hold the machine above shoulder height.

Working Conditions

Operate and start your power tool only outdoors in a well ventilated area. Operate it under good visibility and daylight conditions only. Work carefully.

! WARNING



As soon as the engine is running, this product generates toxic exhaust fumes containing chemicals, such as unburned hydrocarbons (including benzene) and carbon monoxide, that are known to cause respiratory problems, cancer, birth defects, or other reproductive harm. Some of the gases (e.g. carbon monoxide) may be colorless and odorless. To reduce the risk of serious or fatal injury / illness from inhaling toxic fumes, never run the machine indoors or in poorly ventilated locations

! WARNING

If the vegetation being cut or the surrounding ground is coated with a chemical substance (such as an active pesticide or herbicide), read and follow the instructions and warnings that accompanied the substance at issue.

! WARNING

Inhalation of certain dusts, especially organic dusts such as mold or pollen, can cause susceptible persons to have an allergic or asthmatic reaction. Substantial or repeated inhalation of dust and other airborne contaminants, in particular those with a smaller particle size, may cause respiratory or other illnesses. Control dust at the source

where possible. Use good work practices, such as operating the unit so that the wind or operating process directs any dust raised by the power tool away from the operator. Follow the recommendations of EPA / OSHA / NIOSH and occupational and trade associations with respect to dust ("particulate matter".) When the inhalation of dust cannot be substantially controlled, i.e., kept at or near the ambient (background) level, the operator and any bystanders should wear a respirator approved by NIOSH / MSHA for the type of dust encountered.

Operating Instructions

WARNING

Do not operate your power tool using the starting throttle lock, as you do not have control of the engine speed.

In the event of an emergency, switch off the engine immediately – move the slide control / stop switch to **0** or **STOP**.

WARNING

The cutter blades continue to move for a short period after the throttle trigger is released (flywheel effect.)

Accelerating the engine while the blades are blocked increases the load and will cause the clutch to slip continuously. This may result in overheating and damage to important components (e.g. clutch, polymer housing components) – which can then increase the risk of injury from the blades moving while the engine is idling.

WARNING

Before you start work, examine the hedge area for stones, fence wire, metal or other solid objects which could damage the cutter blades.

Take particular care when cutting hedges next to or against wire fences. Do not touch the wire with the cutting blades. When working close to the ground, make sure that no sand, grit or stones get between the cutter blades.

Striking solid foreign objects such as stones, fence wire or metal could damage the cutting attachment and may cause blades to crack, chip or break. STIHL does not recommend the use of your power tool when cutting in areas where the blades could contact such objects.

WARNING

Observe the cutting blades at all times – do not cut any areas of the hedge that you cannot see. When cutting the top of a taller hedge, check the other side of the hedge frequently for bystanders, animals and obstructions.

DANGER



Your power tool is not insulated against electric shock. To reduce the risk of electrocution, never operate this power tool in the vicinity of any wires or cables (power, etc.) which may be carrying electric current.

WARNING

If the cutting tool becomes clogged or stuck, always turn off the engine and make sure the cutting tool has stopped before cleaning. Grass, weeds, etc. should be cleaned off the cutting tool at regular intervals.

Check the cutting blades at regular short intervals during operation, or immediately if there is a noticeable change in cutting behavior:

- Shut off the engine.
- Wait until the cutting blades have come to a complete standstill.
- Check condition and tightness, look for cracks.
- Check sharpness.
- Replace damaged or dull cutting tools immediately, even if they have only superficial cracks.

WARNING

The gearbox becomes hot during operation. To reduce the risk of burn injury, do not touch the gear housing when it is hot.

WARNING

Never modify your muffler. Any modification could cause an increase in heat radiation, sparks or sound level, thereby increasing the risk of fire, burn injury or hearing loss. You may also permanently damage the engine. Have your muffler serviced and repaired by your STIHL servicing dealer only.

! WARNING

The muffler and other parts of the engine (e.g. fins of the cylinder, spark plug) become hot during operation and remain hot for a while after stopping the engine. To reduce risk of burns, do not touch the muffler and other parts while they are hot. Keep the area around the muffler clean. Remove excess lubricant and all debris such as pine needles, branches or leaves. Let the engine cool down sitting on concrete, metal, bare ground or solid wood (e.g. the trunk of a felled tree) away from any combustible substances.

! WARNING

An improperly mounted or damaged cylinder housing or a damaged/deformed muffler shell may interfere with the cooling process of the muffler. To reduce the risk of fire or burn injury, do not continue work with a damaged or improperly mounted cylinder housing or a damaged/deformed muffler shell.

Your muffler is furnished with a spark arresting screen designed to reduce the risk of fire from the emission of hot particles. Never operate your unit with a missing or damaged spark arresting screen. If your gas/oil mix ratio is correct (i.e., not too rich), this screen will normally stay clean as a result of the heat from the muffler and need no service or maintenance. If you experience loss of performance and you suspect a clogged screen, have your muffler maintained by a STIHL servicing dealer. Some state or federal laws or regulations may require a properly

maintained spark arrester for certain uses. See the "Maintenance, Repair and Storing" section of these Safety Precautions. Remember that the risk of a brush or forest fire is greater in hot or dry conditions.

! WARNING



Some STIHL power tools are equipped with a catalytic converter, which is designed to reduce the exhaust emissions of the engine by a chemical process in the muffler. Due to this process, the muffler does not cool down as rapidly as conventional mufflers when the engine returns to idle or is shut off. To reduce the risk of fire and burn injuries when using a catalytic converter, always set your power tool down in the upright position and never locate it where the muffler is near dry brush, grass, wood chips or other combustible materials while it is still hot.

After Finishing Work

Always clean dust and dirt off the machine – do not use any grease solvents for this purpose.

Spray the blades with STIHL resin solvent. Start and run the engine briefly so that the solvent is evenly distributed.

MAINTENANCE, REPAIR AND STORING

Maintenance, replacement, or repair of the emission control devices and systems may be performed by any nonroad engine repair establishment or individual. However, if you make a warranty claim for a component which has not been serviced or maintained properly or if nonapproved replacement parts were used, STIHL may deny coverage.

! WARNING

Use only identical STIHL replacement parts for maintenance and repair. Use of non-STIHL parts may cause serious or fatal injury.

Strictly follow the maintenance and repair instructions in the appropriate section of your instruction manual. Please also refer to the maintenance chart in this manual.

! WARNING

Always stop the engine and make sure that the cutting blades are stopped before doing any maintenance or repair work or cleaning the power tool. Do not attempt any maintenance or repair work not described in your instruction manual. Have such work performed by your STIHL servicing dealer only.

Wear gloves when handling or performing maintenance on blades.

! WARNING

Use the specified spark plug and make sure it and the ignition lead are always clean and in good condition. Always press spark plug boot snugly onto spark plug terminal of the proper size. (Note: If terminal has detachable SAE adapter nut, it must be securely attached.) A loose connection between spark plug terminal and the ignition wire connector in the boot may create arcing that could ignite combustible fumes and cause a fire.

! WARNING

Never test the ignition system with the ignition wire boot removed from the spark plug or with a removed spark plug, since uncontained sparking may cause a fire.

! WARNING

Do not operate your power tool if the muffler is damaged, missing or modified. An improperly maintained muffler will increase the risk of fire and hearing loss. Your muffler is equipped with a spark-arresting screen to reduce the risk of fire; never operate your power tool if the screen is missing, damaged or clogged. Remember that the risk of a brush or forest fire is greater in hot or dry weather.

In California, it is a violation of § 4442 or § 4443 of the Public Resources Code to use or operate gasoline-powered tools on forest-covered, brush-covered or grass-covered land unless the engine's exhaust system is equipped with a complying spark arrester that is maintained in effective working order.

The owner/operator of this product is responsible for properly maintaining the spark arrester. Other states or governmental entities/agencies, such as the U.S. Forest Service, may have similar requirements. Contact your local fire agency or forest service for the laws or regulations relating to fire protection requirements.

! WARNING

Never repair damaged cutting attachments by welding, straightening or modifying the shape. This may cause parts of the cutting blades to come off and result in serious or fatal injuries.

Keep the cutting blades sharp. Tighten all nuts, bolts and screws, except the carburetor adjustment screws, after each use.

Do not clean your machine with a pressure washer. The solid jet of water may damage parts of the machine.

Store the power tool in a dry and high or locked location out of reach of children.

Before storing for longer than a few days, always empty the fuel tank. See chapter "Storing the machine" in this manual.

Using the Unit**Cutting Season**

Observe country-specific or municipal rules and regulations for cutting hedges.

Do not use your power tool during other people's normal rest periods.

Cutting Sequence

Use lopping shears or a chain saw to cut out thick branches first.

Cut both sides of the hedge first, then the top.

Disposal

Do not throw cuttings in the garbage can – they can be composted!

Working Technique

Vertical Cut

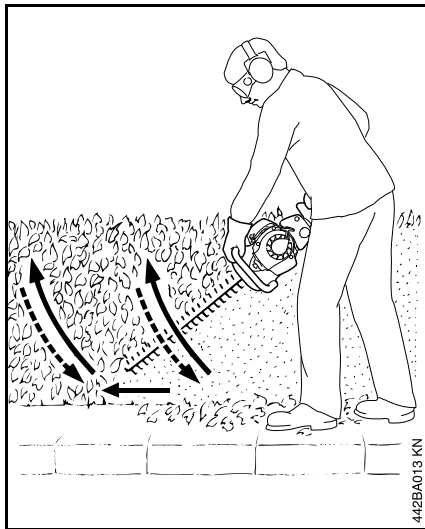

Swing the cutting blade from the bottom upwards in an arc – lower the nose of the blade, move along the hedge and then swing the blade up again in an arc.

Any working position above head height is tiring. To minimize the risk of accidents, work in such positions for short periods only.

Horizontal Cut

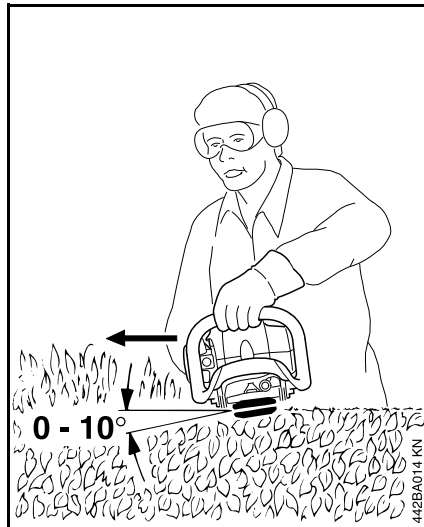

Hold the cutter bar at an angle of 0° to 10° as you swing the hedge trimmer horizontally.

Swing the cutting blade in an arc towards the outside of the hedge so that the cuttings are swept to the ground.

Fuel

This engine is certified to operate on unleaded gasoline and the STIHL two-stroke engine oil at a mix ratio of 50:1.

Your engine requires a mixture of high-quality gasoline and two-stroke air cooled engine oil.

Use mid-grade unleaded gasoline with a minimum octane rating of 89 ((R+M)/2) and no more than 10% ethanol content.

Fuel with a lower octane rating may increase engine temperatures. This, in turn, increases the risk of piston seizure and damage to the engine.

The chemical composition of the fuel is also important. Some fuel additives not only detrimentally affect elastomers (carburetor diaphragms, oil seals, fuel lines, etc.), but magnesium castings and catalytic converters as well. This could cause running problems or even damage the engine. For this reason STIHL recommends that you use only high-quality unleaded gasoline!

Gasoline with an ethanol content of more than 10% can cause running problems and major damage in engines and should not be used.

The ethanol content in gasoline affects engine running speed – it may be necessary to readjust the carburetor if you use fuels with various ethanol contents.

WARNING

To reduce the risk of personal injury from loss of control and/or contact with the running cutting tool, do not use your

unit with incorrect idle adjustment. At correct idle speed, the cutting tool should not move.

If your power tool shows an incorrect idle adjustment, have your STIHL dealer check your power tool and make proper adjustments and repairs.

The idle speed and maximum speed of the engine change if you switch from a fuel with a certain ethanol content to another fuel with a much higher or lower ethanol content.

This problem can be avoided by always using fuel with the same ethanol content.

Use only STIHL two-stroke engine oil or equivalent high-quality two-stroke engine oils that are designed for use only in air cooled two-cycle engines.

We recommend STIHL HP Ultra 2-Cycle Engine Oil since it is specially formulated for use in STIHL engines.

Do not use BIA or TCW rated (two-stroke water cooled) mix oils or other mix oils that state they are for use in both water cooled and air cooled engines (e.g., outboard motors, snowmobiles, chain saws, mopeds, etc.).

WARNING

Take care when handling gasoline. Avoid direct contact with the skin and avoid inhaling fuel vapor. When filling at the pump, first remove the container from your vehicle and place the container on the ground before filling. To reduce the risk of sparks from static discharge and resulting fire and/or explosion, do not fill fuel containers that are sitting in or on a vehicle or trailer.

The container should be kept tightly closed in order to limit the amount of moisture that gets into the mixture.

The machine's fuel tank should be cleaned as necessary.

Fuel mix ages

Only mix sufficient fuel for a few days work, not to exceed 30 days of storage. Store in approved fuel-containers only. When mixing, pour oil into the container first, and then add gasoline. Close the container and shake it vigorously by hand to ensure proper mixing of the oil with the fuel.

Gasoline	Oil (STIHL 50:1 or equivalent high-quality oils)
US gal.	US fl.oz.
1	2.6
2 1/2	6.4
5	12.8

Dispose of empty mixing-oil containers only at authorized disposal locations.

Fueling

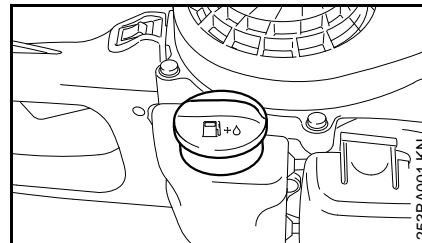

Before fueling, clean the filler cap and the area around it to ensure that no dirt falls into the tank.

Always thoroughly shake the mixture in the canister before fueling your machine.

WARNING

In order to reduce the risk of fire and personal injury from escaping gas vapor and fumes, remove the fuel filler cap carefully so as to allow any pressure build-up in the tank to release slowly.

WARNING

After fueling, tighten fuel cap **as securely as possible** by hand.

Have the fuel pickup body in the tank changed once every year.

Starting / Stopping the Engine

- Observe safety precautions – see chapter on "Safety Precautions and Working Techniques".

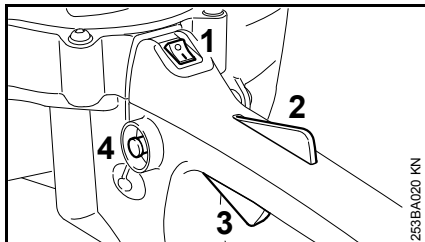

- Move the stop switch (1) to I.
- Press down the lockout lever (2) and squeeze the throttle trigger (3) – hold both levers in that position.
- Press in the starting throttle lock (4).
- Let go of the lockout lever, throttle trigger and starting throttle lock. This is the starting throttle position.

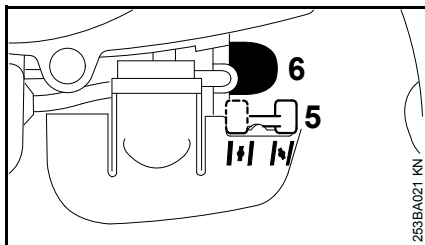

- Set the choke lever (5) to

⌂ if the engine is cold

|+| for warm start – also use this position if the engine has been running but is still cold.

- Press the manual fuel pump bulb (6) at least five times – even if the bulb is filled with fuel.

Cranking

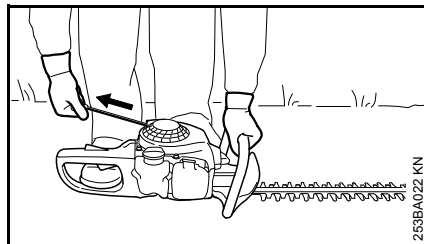

- Place the unit on the ground.
- Remove the blade scabbard. Check that the cutting blades are not touching the ground or any other obstacles.
- Make sure you have a safe and secure footing.
- Hold the unit firmly with your left hand on the front handle and press down.
- Pull the starter grip slowly with your right hand until you feel it engage and then give it a brisk strong pull.

NOTICE

Do not pull out the starter rope all the way – it might otherwise break.

- Do not let the starter grip snap back. Guide it slowly back into the housing so that the starter rope can rewind properly.

If the engine is cold (choke set to ⌂)

- Pull the starter rope five times.
- Set choke lever to |+| and
- continue cranking until the engine runs.

If conditions are unfavorable and the engine does not start after 10 pulls with the choke lever set to |+| :

- Set choke to ⌂ and pull starter rope five times. Set choke to |+| and continue cranking.

If the engine is warm (choke set to |+|)

- Continue cranking until the engine runs.

As Soon as Engine Runs

- Blip the throttle trigger – the engine settles down to idle speed.

If the engine stops during warm-up or acceleration

- Repeat the starting procedure as described under "If the engine is cold".



WARNING

Make sure the carburetor is correctly adjusted. The cutting blades must not move when the engine is idling.

Your machine is now ready for operation.

Stopping the Engine

- Move the stop switch to O.

Other Hints on Starting

If the engine does not start

- Make sure all settings are correct (choke shutter, throttle trigger in starting throttle position, stop switch to I).
- Repeat the starting procedure.

If the engine still does not start

- Remove the spark plug – see "Spark Plug".
- Dry the spark plug.
- Open the throttle wide.
- Crank the engine several times with the starter to clear the combustion chamber.
- Install the spark plug – see "Spark Plug".
- Move the stop switch to I.
- Set choke lever to |↑| – even if the engine is cold.
- Now start the engine.

If fuel tank has been run completely dry and then refueled

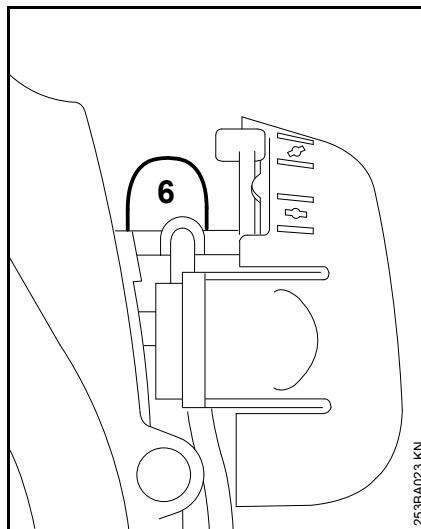

- Press the manual fuel pump bulb (6) at least five times – even if the bulb is filled with fuel.
- Now start the engine.

Operating Instructions

During break-in period

A factory-new machine should not be run at high revs (full throttle off load) for the first three tank fillings. This avoids unnecessary high loads during the break-in period. As all moving parts have to bed in during the break-in period, the frictional resistances in the engine are greater during this period. The engine develops its maximum power after about 5 to 15 tank fillings.

During Operation

After a long period of full throttle operation, allow the engine to run for a short while at idle speed so that engine heat can be dissipated by the flow of cooling air. This protects engine-mounted components (ignition, carburetor) from thermal overload.

After Finishing Work

Storing for a short period: Wait for the engine to cool down. Empty the fuel tank and keep the machine in a dry place, well away from sources of ignition, until you need it again. For longer out-of-service periods – see "Storing the Machine".

Cleaning the Air Filter

If there is a noticeable loss of engine power

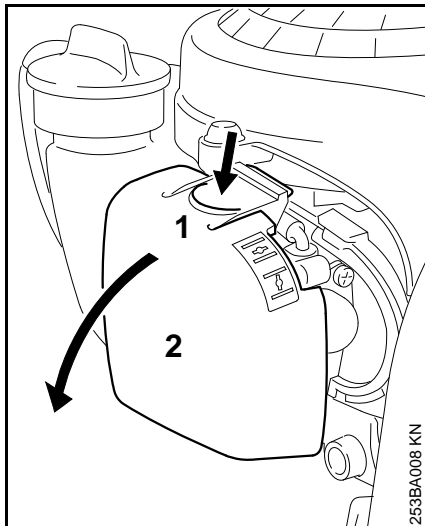

- Move the choke lever to .
- Press in the tab (1) and swing the filter cover (2) down.
- Clean away loose dirt from around the filter.

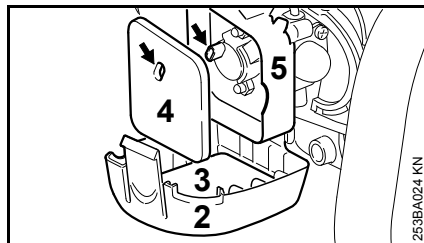

- Remove the foam element (3) and felt element (4).
- Wash the foam element in a clean, non-flammable solution (e.g. soapy water) and then dry.
- Fit a new felt element. As a temporary measure you can knock it out on the palm of your hand or blow it out with compressed air. Do not wash.
- Replace any damaged parts.
- Fit the foam element (3) in the filter cover (2) and the felt element (4) in the filter housing (5).
- Close the filter cover so that it snaps into position.

Engine Management

Exhaust emissions are controlled by the design of the fundamental engine parameters and components (e.g. carburation, ignition, timing and valve or port timing) without the addition of any major hardware.

Adjusting the Carburetor

General Information

The carburetor comes from the factory with a standard setting.

This setting provides an optimum fuel-air mixture under most operating conditions.

Preparations

- Shut off the engine.
- Check the air filter and clean or replace if necessary.
- Inspect cutting blades and clean if necessary (clean, move freely, not warped).

Standard Setting

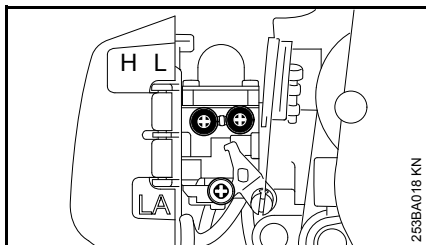

- Turn high speed screw (H) counterclockwise as far as stop (no more than 3/4 turn).
- Turn the low speed screw (L) clockwise as far as stop, then turn it back 3/4 turn.

Adjusting Idle Speed

- Carry out the standard setting.
- Start and warm up the engine.

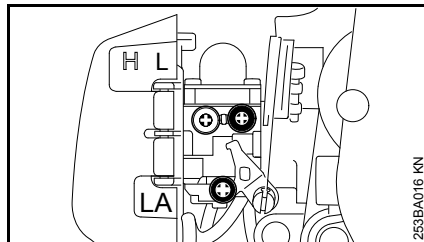

- Adjust idle speed with the idle speed screw (LA) so that the cutting blades do not run.

Engine stops while idling

- Turn the idle speed screw (LA) slowly clockwise until the engine runs smoothly – the cutting blades must not run.

Cutting blades run when engine is idling

- Turn the idle speed screw (LA) counterclockwise until the cutting blades stop moving – then turn it another 1/2 to 1 turn in the same direction.

WARNING

If the cutting blades continue moving when the engine is idling, have your power tool checked and repaired by your servicing dealer.

Erratic idling behavior, poor acceleration (despite correction to setting of LA screw).

Idle setting is too lean

- Turn the low speed screw (L) slowly counterclockwise until the engine runs and accelerates smoothly.

It is usually necessary to change the setting of the idle speed screw (LA) after every correction to the low speed screw (L).

Fine Tuning for Operation at High Altitude

A slight correction of the setting may be necessary if engine does not run satisfactorily:

- Carry out the standard setting.
- Warm up the engine.
- Turn high speed screw (H) slightly clockwise (leaner) – no further than stop.

NOTICE

After returning from high altitude, reset the carburetor to the standard setting.

If the setting is too lean there is a risk of engine damage due to insufficient lubrication and overheating.

Spark Plug

If engine is down on power, difficult to start or runs poorly at idling speed, first check the spark plug.

Fit a new spark plug after approx. 100 operating hours or earlier if the electrodes are badly eroded.

Wrong fuel mix (too much engine oil in the gasoline), a dirty air filter and unfavorable running conditions (mostly at part throttle etc.) affect the condition of the spark plug. These factors cause deposits to form on the insulator nose which may result in trouble in operation.

Removing the Spark Plug

- Move the stop switch to **O**.

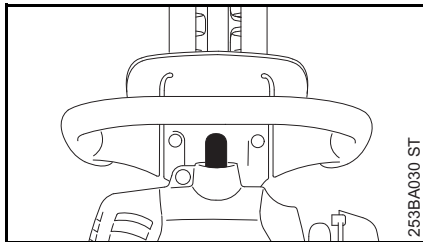

- Pull off the spark plug boot.
- Unscrew the spark plug.

Checking the Spark Plug

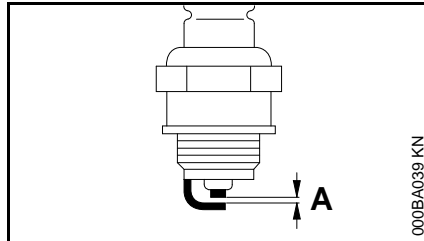

- Clean dirty spark plug.
- Check electrode gap (A) and readjust if necessary – see "Specifications."
- Use only resistor type spark plugs of the approved range.

Rectify problems that have caused fouling of spark plug:

- too much oil in fuel mix,
- dirty air filter,
- unfavorable running conditions, e.g. operating at part load.

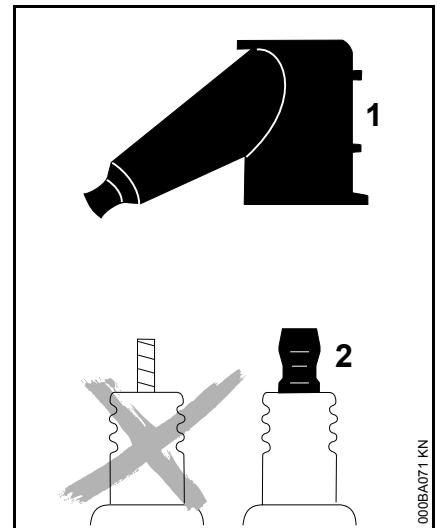

! WARNING

To reduce the risk of fire and burn injury, use only spark plugs authorized by STIHL. Always press spark plug boot (1) snugly onto spark plug terminal (2) of the proper size. (Note: If terminal has detachable SAE adapter nut, it must be securely attached.) A loose connection between spark plug boot and ignition wire connector in the boot may create arcing that could ignite combustible fumes and cause a fire.

Installing the spark plug

- Fit the spark plug by hand and screw it in
- Tighten spark plug with combination wrench
- Press the spark plug boot firmly onto the spark plug

Engine Running Behavior

If engine running behavior is unsatisfactory even though the air filter is clean and the carburetor is properly adjusted, the cause may be the muffler.

Have the muffler checked for contamination (carbonization) by your servicing dealer.

STIHL recommends that you have servicing and repair work carried out exclusively by an authorized STIHL servicing dealer.

Lubricating the Gearbox

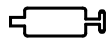

Use STIHL gear lubricant for hedge trimmers (special accessory) to lubricate the blade drive gear.

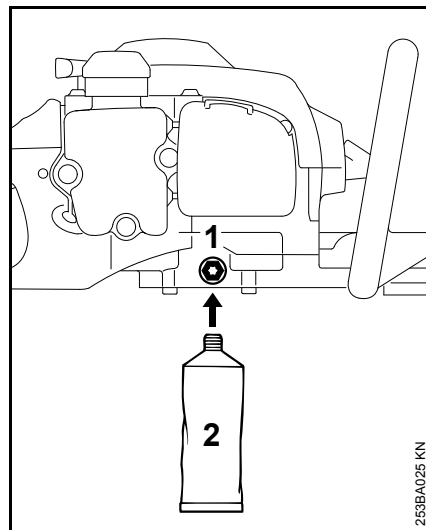

After about 50 hours of operation:

- Remove the screw plug (1) from the gearbox.
- Screw the tube of grease (2) into the filler hole.
- Squeeze up to 1/4 oz (5 g) grease into the gearbox.

NOTICE

Do not completely fill the gearbox with grease.

- Remove the tube of grease (2).
- Refit the filler plug and tighten it down firmly.

Rewind Starter

To help prolong the wear life of the starter rope, observe the following points:

- Pull the starter rope only in the direction specified.
- Do not pull the rope over the edge of the guide bushing.
- Do not pull out the rope more than specified.
- Do not allow the starter grip to snap back, guide it back into the housing slowly – see chapter on "Starting / Stopping the Engine."

Have a damaged starter rope replaced by your dealer before it breaks completely. STIHL recommends that you have servicing and repair work carried out exclusively by an authorized STIHL servicing dealer.

Storing the Machine

For periods of 3 months or longer

- Drain and clean the fuel tank in a well ventilated area.
- Dispose of fuel properly in accordance with local environmental requirements.
- Run the engine until the carburetor is dry – this helps prevent the carburetor diaphragms sticking together.
- Clean the cutting blades, check condition and spray with STIHL resin solvent.
- Fit the blade scabbard.
- Thoroughly clean the machine – pay special attention to the cylinder fins and air filter.
- Store the machine in a dry and safe location (use the ring integrated in the rear handle) out of the reach of children and other unauthorized persons.

Sharpening Instructions

When cutting performance and behavior begin to deteriorate, i.e. blades frequently snag on branches: Resharpener the cutting blades.

It is best to have the cutting blades resharpened by a dealer on a workshop sharpener. STIHL recommends a STIHL servicing dealer.

It is also possible to use a flat crosscut sharpening file. Hold the sharpening file at the prescribed angle (see "Specifications").

- Only sharpen the cutting edge – do not file blunt projecting parts of the cutting blade or the cutting blade guard (see "Main Parts and Controls")
- Always file towards the cutting edge.
- The file only sharpens on the forward stroke – lift it off the blade on the backstroke.
- Use a whetstone to remove burr from cutting edge.
- Remove as little material as possible.
- After sharpening, clean away filing or grinding dust and then spray the cutting blades with STIHL resin solvent.

NOTICE

Do not operate your machine with dull or damaged cutting blades. This may cause overload and will give unsatisfactory cutting results.

Inspections and Maintenance by Dealer

Maintenance Work

STIHL recommends that you have servicing and repair work carried out exclusively by an authorized STIHL servicing dealer.

Fuel Pickup Body in Tank

- Have the pickup body in the fuel tank replaced every year.

Spark Arrestor in Muffler

- If the engine is low on power, have your dealer check the spark arrestor (country-specific option) in the muffler.

Maintenance and Care

The following intervals apply to normal operating conditions only. If your daily working time is longer or operating conditions are difficult (very dusty work area, etc.), shorten the specified intervals accordingly.		before starting work	after finishing work or daily	after each refueling stop	weekly	monthly	every 12 months	if problem	if damaged	as required
Complete machine	Visual inspection (condition, leaks)	X		X						
	Clean		X							
Control handle	Check operation	X		X						
Air filter	Clean							X		X
	Replace								X	
Manual fuel pump (if fitted)	Check	X								
	Have repaired by servicing dealer ¹⁾								X	
Pickup body in fuel tank	Have checked by servicing dealer ¹⁾							X		
	Have replaced by servicing dealer ¹⁾					X			X	X
Fuel tank	Clean							X		X
Carburetor	Check idle adjustment	X		X						
	Readjust idle									X
Spark plug	Readjust electrode gap							X		
	Replace after every 100 operating hours									
Cooling inlets	Visual inspection		X							
	Clean									X
Spark arresting screen ²⁾ in muffler	Have checked by servicing dealer ¹⁾								X	
	Have cleaned or replaced by servicing dealer ¹⁾									X
All accessible screws and nuts (not adjusting screws)	Retighten									X
Antivibration elements	Visual inspection	X								
	Have replaced by servicing dealer ¹⁾							X	X	

The following intervals apply to normal operating conditions only. If your daily working time is longer or operating conditions are difficult (very dusty work area, etc.), shorten the specified intervals accordingly.		before starting work	after finishing work or daily	after each refueling stop	weekly	monthly	every 12 months	if problem	if damaged	as required
Cutting blades	Clean		X							
	Sharpen									X
	Visual inspection	X								
	Have replaced by servicing dealer ¹⁾								X	
Gearbox lubrication	Check and replenish after every 50 hours of operation									
Safety labels	Replace								X	

¹⁾ STIHL recommends an authorized STIHL servicing dealer.

²⁾ not in all versions, market-specific

Main Parts

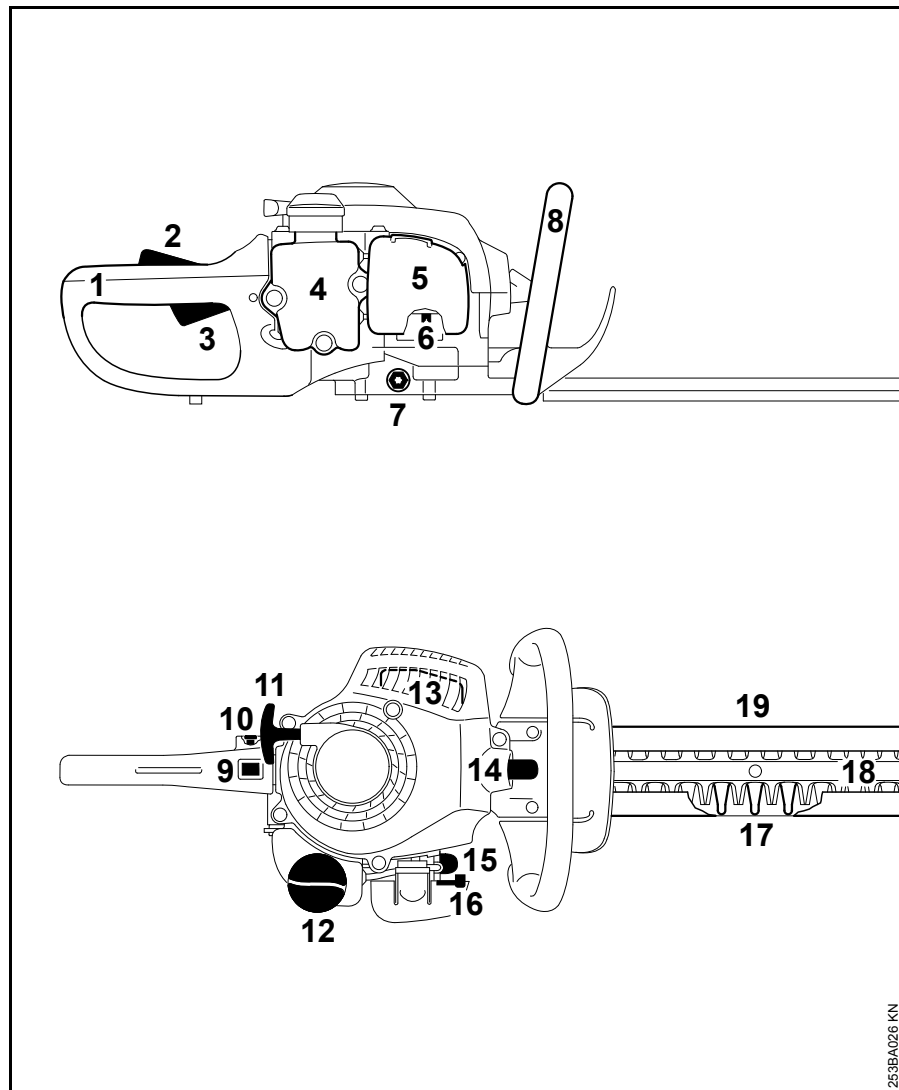

- 1 Rear Handle
- 2 Throttle Trigger Lockout
- 3 Throttle Trigger
- 4 Fuel Tank
- 5 Air Filter Cover
- 6 Carburetor Adjusting Screws
- 7 Screw Plug
- 8 Front Handle
- 9 Stop Switch
- 10 Starting Throttle Lock
- 11 Starter Grip
- 12 Fuel Filler Cap
- 13 Muffler
- 14 Spark Plug Boot
- 15 Manual Fuel Pump
- 16 Choke Lever
- 17 Cutting Blade Guard
- 18 Cutting Blades
- 19 Blade Scabbard

Definitions

1. **Rear Handle**
The support handle for the hand, located at or toward the rear of the hedge trimmer.
2. **Throttle Trigger Lockout**
Must be depressed before the throttle trigger can be activated.
3. **Throttle Trigger**
Controls the speed of the engine.
4. **Fuel Tank**
For fuel and oil mixture.
5. **Air Filter Cover**
Covers and protects the air filter element.
6. **Carburetor Adjusting Screws**
For tuning the carburetor.
7. **Screw Plug**
Seals filler opening for gearbox grease.
8. **Front Handle**
Handle bar for the hand at front of hedge trimmer.
9. **Stop Switch**
Switches the engine's ignition off and stops the engine.
10. **Starting Throttle Lock**
Keeps the throttle partially open during starting.
11. **Starter Grip**
The grip of the pull starter, for starting the engine.
12. **Fuel Filler Cap**
For closing the fuel tank.

13. **Muffler**
Reduces engine exhaust noises and diverts exhaust gases away from operator.
14. **Spark Plug Boot**
Connects the spark plug with the ignition lead.
15. **Manual Fuel Pump**
Provides additional fuel feed for a cold start.
16. **Choke Lever**
Eases engine starting by enriching mixture.
17. **Cutting Blade Guard**
Helps to reduce the risk of operator contact by the cutter blade.
18. **Cutting Blades**
Steel blades for cutting hedges and shrubs.
19. **Blade Scabbard**
Covers cutting blades when hedge trimmer is not in use.

Specifications

EPA / CEPA

The Emission Compliance Period referred to on the Emissions Compliance Label indicates the number of operating hours for which the engine has been shown to meet Federal emission requirements.

Category

A = 300 hours

B = 125 hours

C = 50 hours

CARB

The Emission Compliance Period used on the CARB-Air Index Label indicates the terms:

Extended = 300 hours

Intermediate = 125 hours

Moderate = 50 hours

Engine

STIHL single cylinder two-stroke engine

Displacement:	27.2 cc (1.66 cu.in)
Bore:	34 mm (1.34 in)
Stroke:	30 mm (1.18 in)
Engine power to ISO 7293:	0.75 kW (1 bhp) at 8,500 rpm
Idle speed:	2,800 rpm
Cut-off speed:	10,300 rpm

Ignition System

Electronic (breakerless) magneto ignition

Spark plug (resistor type): Bosch WSR 6 F, NGK BPMR 7 A

Electrode gap: 0.5 mm (0.020 in)

Fuel System

All position diaphragm carburetor with integral fuel pump

Fuel tank capacity: 0.225 l (7.6 fl.oz)

Weight

complete with cutting attachment, dry
450 mm (18 in)

blade: 4.7 kg (10.4 lbs)

600 mm (24 in)

blade: 5.0 kg (11 lbs)

Cutting blades

Sharpening angle to
horizontal: 35°

Maintenance and Repairs

Users of this unit should carry out only the maintenance operations described in this manual. STIHL recommends that other repair work be performed only by authorized STIHL servicing dealers.

Warranty claims following repairs can be accepted only if the repair has been performed by an authorized STIHL servicing dealer using genuine STIHL replacement parts.

Genuine STIHL parts can be identified by the STIHL part number, the **STIHL** logo and, in some cases, by the STIHL parts symbol . The symbol may appear alone on small parts.

Disposal

Observe all country-specific waste disposal rules and regulations.

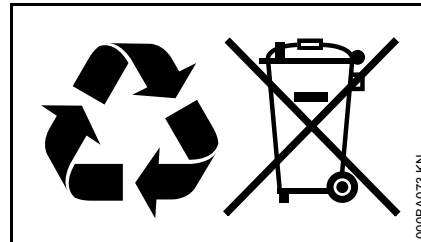

STIHL products must not be thrown in the garbage can. Take the product, accessories and packaging to an approved disposal site for environment-friendly recycling.

Contact your STIHL servicing dealer for the latest information on waste disposal.

STIHL Incorporated Federal Emission Control Warranty Statement

Not for California

Your Warranty Rights and Obligations

The U.S. Environmental Protection Agency (EPA) and STIHL Incorporated are pleased to explain the Emission Control System Warranty on your equipment type engine. In the U.S. new 1997 and later model year small off-road equipment engines must be designed, built and equipped, at the time of sale, to meet the U.S. EPA regulations for small non road engines. The equipment engine must be free from defects in materials and workmanship which cause it to fail to conform with U.S. EPA standards for the first two years of engine use from the date of sale to the ultimate purchaser.

STIHL Incorporated must warrant the emission control system on your small off-road engine for the period of time listed below provided there has been no abuse, neglect or improper maintenance of your small off-road equipment engine.

Your emission control system includes parts such as the carburetor and the ignition system. Also included may be hoses, and connectors and other emission-related assemblies.

Where a warrantable condition exists, STIHL Incorporated will repair your small off-road equipment engine at no cost to you, including diagnosis (if the diagnostic work is performed at an authorized dealer), parts, and labor.

Manufacturer's Warranty Coverage

In the U.S., 1997 and later model year small off-road equipment engines are warranted for two years. If any emission-related part on your engine is defective, the part will be repaired or replaced by STIHL Incorporated free of charge.

Owner's Warranty Responsibilities

As the small off-road equipment engine owner, you are responsible for the performance of the required maintenance listed in your instruction manual. STIHL Incorporated recommends that you retain all receipts covering maintenance on your small off-road equipment engine, but STIHL Incorporated cannot deny warranty solely for the lack of receipts or for your failure to ensure the performance of all scheduled maintenance.

Any replacement part or service that is equivalent in performance and durability may be used in non-warranty maintenance or repairs, and shall not reduce the warranty obligations of the engine manufacturer.

As the small off-road equipment engine owner, you should be aware, however, that STIHL Incorporated may deny you warranty coverage if your small off-road equipment engine or a part has failed due to abuse, neglect, improper maintenance or unapproved modifications.

You are responsible for presenting your small off-road equipment engine to a STIHL service center as soon as a problem exists. The warranty repairs will be completed in a reasonable amount of time, not to exceed 30 days.

If you have any questions regarding your warranty rights and responsibilities, please contact a STIHL customer service representative at 1-800-467-8445 or you can write to

STIHL Inc.,
536 Viking Drive, P.O. Box 2015,
Virginia Beach, VA 23450-2015

www.stihlusa.com

Coverage by STIHL Incorporated

STIHL Incorporated warrants to the ultimate purchaser and each subsequent purchaser that your small off-road equipment engine will be designed, built and equipped, at the time of sale, to meet all applicable regulations. STIHL Incorporated also warrants to the initial purchaser and each subsequent purchaser that your engine is free from defects in materials and workmanship which cause the engine to fail to conform with applicable regulations for a period of two years.

Warranty Period

The warranty period will begin on the date the utility equipment engine is purchased by the initial purchaser and you have signed and sent back the warranty card to STIHL.

If any emission-related part on your engine is defective, the part will be replaced by STIHL Incorporated at no cost to the owner. Any warranted part which is not scheduled for replacement as required maintenance, or which is scheduled only for regular inspection to the effect of "repair or replace as necessary" will be warranted for the warranty period. Any warranted part which is scheduled for replacement as

required maintenance will be warranted for the period of time up to the first scheduled replacement point for that part.

Diagnosis

You, as the owner, shall not be charged for diagnostic labor which leads to the determination that a warranted part is defective. However, if you claim warranty for a component and the machine is tested as non-defective, STIHL Incorporated will charge you for the cost of the emission test. Mechanical diagnostic work will be performed at an authorized STIHL servicing dealer. Emission test may be performed either at STIHL Incorporated or at any independent test laboratory.

Warranty Work

STIHL Incorporated shall remedy warranty defects at any authorized STIHL servicing dealer or warranty station. Any such work shall be free of charge to the owner if it is determined that a warranted part is defective.

Any manufacturer-approved or equivalent replacement part may be used for any warranty maintenance or repairs on emission-related parts and must be provided without charge to the owner. STIHL Incorporated is liable for damages to other engine components caused by the failure of a warranted part still under warranty.

The following list specifically defines the emission-related warranted parts:

- Air Filter
- Carburetor (if applicable)
- Fuel Pump

- Choke (Cold Start Enrichment System) (if applicable)
- Control Linkages
- Intake Manifold
- Magneto or Electronic Ignition System (Ignition Module or Electronic Control Unit)
- Fly Wheel
- Spark Plug
- Injection Valve (if applicable)
- Injection Pump (if applicable)
- Throttle Housing (if applicable)
- Cylinder
- Muffler
- Catalytic Converter (if applicable)
- Fuel Tank
- Fuel Cap
- Fuel Line
- Fuel Line Fittings
- Clamps
- Fasteners

Where to make a Claim for Warranty Service

Bring the product to any authorized STIHL servicing dealer and present the signed warranty card.

Maintenance Requirements

The maintenance instructions in this manual are based on the application of the recommended 2-stroke fuel-oil mixture (see also instruction "Fuel"). Deviations from this recommendation

regarding quality and mixing ratio of fuel and oil may require shorter maintenance intervals.

Limitations

This Emission Control Systems Warranty shall not cover any of the following:

- repair or replacement required because of misuse, neglect or lack of required maintenance,
 - repairs improperly performed or replacements not conforming to STIHL Incorporated specifications that adversely affect performance and/or durability, and alterations or modifications not recommended or approved in writing by STIHL Incorporated,
- and
- replacement of parts and other services and adjustments necessary for required maintenance at and after the first scheduled replacement point.

STIHL Incorporated California Exhaust and Evaporative Emissions Control Warranty Statement

For California only

Your Warranty Rights and Obligations

The California Air Resources Board (CARB) and STIHL Incorporated are pleased to explain the emission control system warranty on your 2014 and later small off-road equipment engine.

In California, new equipment that uses small off-road engines must be designed, built, and equipped to meet the State's stringent anti-smog standards. STIHL Incorporated must warrant the emissions control system on your small off-road engine for the period listed below provided there has been no abuse, neglect or improper maintenance of your small off-road engine.

Your emissions control system may include parts such as the carburetor or fuel-injection system, the ignition system, and catalytic converter. Also included may be hoses, belts, connectors or other emission-related assemblies.

Where a warrantable condition exists, STIHL Incorporated will repair your small off-road equipment engine at no cost to you including diagnosis, parts and labor.

Manufacturer's Warranty Responsibilities

This emissions control system is warranted for two years in California. If any emissions-related part on your equipment is defective, the part will be repaired or replaced by STIHL Incorporated free of charge.

Owner's Warranty Responsibilities

As the small off-road equipment engine owner, you are responsible for performance of the required maintenance listed in your instruction manual. STIHL Incorporated recommends that you retain all receipts covering maintenance on your small off-road equipment engine, but STIHL Incorporated cannot deny warranty solely for the lack of receipts or your failure to ensure the performance of all scheduled maintenance.

As the small off-road equipment engine owner, you should however be aware that STIHL Incorporated may deny you warranty coverage if your small off-road equipment engine or a part has failed due to abuse, neglect, or improper maintenance or unapproved modifications.

You are responsible for presenting your small off-road equipment engine to a STIHL servicing dealer as soon as the problem exists. The warranty repairs should be completed in a reasonable amount of time, not to exceed 30 days. If you have any questions regarding your warranty rights and responsibilities, please contact a STIHL customer service representative at 1-800-467-8445 or you can write to

STIHL Inc., 536 Viking Drive,
P.O. Box 2015,
Virginia Beach, VA 23450-2015.

www.stihlusa.com

Coverage by STIHL Incorporated

STIHL Incorporated warrants to the ultimate purchaser and each subsequent purchaser that your small off-road equipment engine is designed, built and equipped, at the time of sale, to meet all applicable emission regulations.

STIHL Incorporated also warrants to the initial purchaser and each subsequent purchaser that your engine is free from defects in materials and workmanship which cause the engine to fail to conform to applicable emission regulations for a period of two years.

Defects Warranty Period

The warranty periods will begin on the date the utility equipment engine is purchased by the initial purchaser. If any emission-related part on your engine is defective, the part will be replaced by STIHL Incorporated at no cost to the owner.

Add-on or modified parts that are not exempted by CARB may not be used. The use of any non-exempted add-on or modified parts will be grounds for disallowing a warranty claim. STIHL Incorporated will not be liable to warrant failures of warranted parts caused by the use of a non-exempted add-on or modified part.

The warranty on emissions-related parts will be interpreted as follows:

1. Any warranted part that is not scheduled for replacement as required maintenance in the written instructions required in the Emission Warranty Parts List (see below) must be warranted for the warranty period defined in Subsection COVERAGE BY STIHL INCORPORATED, see above. If any such part fails during the period of warranty coverage, it must be repaired or replaced by the manufacturer according to Subsection (4) below. Any such part repaired or replaced under the warranty must be warranted for the remaining warranty period.
2. Any warranted part that is scheduled only for regular inspection in the written instructions required by the Emission Warranty Parts List (see below) must be warranted for the warranty period defined in Subsection COVERAGE BY STIHL INCORPORATED, see above. A statement in such written instructions to the effect of "repair or replace as necessary" will not reduce the period of warranty coverage. Any such part repaired or replaced under warranty must be warranted for the remaining warranty period.
3. Any warranted part that is scheduled for replacement as required maintenance in the written instructions required by the Emission Warranty Parts List (see below) must be warranted for the period of time prior to the first scheduled replacement point for

that part. If the part fails prior to the first scheduled replacement, the part must be repaired or replaced by the engine manufacturer according to Subsection (4) below. Any such part repaired or replaced under warranty must be warranted for the remainder of the period prior to the first scheduled replacement point for the part.

4. Repair or replacement of any warranted part under the warranty must be performed at a warranty station at no charge to the owner.
5. Notwithstanding the provisions of Subsection (4) above, warranty services or repairs will be provided at all manufacturer distribution centers that are authorized to service the subject engines.
6. The owner must not be charged for diagnostic labor that leads to the determination that a warranted part is in fact defective, provided that such diagnostic work is performed at a warranty station.

Warranty Work

STIHL Incorporated shall remedy warranty defects at any authorized STIHL servicing dealer or warranty station. Any such work shall be free of charge to the owner if it is determined that a warranted part is defective. Any manufacturer approved or equivalent replacement part may be used for any warranty maintenance or repairs on emission-related parts and must be provided without charge to the owner. STIHL Incorporated is liable for

damages to other engine components caused by the failure of a warranted part still under warranty.

Emission Warranty Parts List

Air Filter, Carburetor (if applicable), Fuel Pump, Choke (Cold Start Enrichment System) (if applicable), Control Linkages, Intake Manifold, Magneto or Electronic Ignition System (Ignition Module or Electronic Control Unit), Fly Wheel, Spark Plug, Injection Valve (if applicable), Injection Pump (if applicable), Throttle Housing (if applicable), Cylinder, Muffler, Catalytic Converter (if applicable), Fuel Tank, Fuel Cap, Fuel Line, Fuel Line Fittings, Clamps, Fasteners.

Where to make a Claim for Warranty Service

Bring the STIHL product to any authorized STIHL servicing dealer and present the signed STIHL product registration card, or the print-out of the electronic product registration.

Limitations

The repair or replacement of any warranted part otherwise eligible for warranty coverage may be excluded from such warranty coverage if STIHL Incorporated demonstrates that the STIHL product has been abused, neglected, or improperly maintained, and that such abuse, neglect, or improper maintenance was the direct cause of the need for repair or replacement of the part. That notwithstanding, any adjustment of a component that has a factory installed,

and properly operating, adjustment limiting device is still eligible for warranty coverage.

Trademarks

STIHL Registered Trademarks

STIHL®

STIHL®



The color combination orange-grey (U.S. Registrations #2,821,860; #3,010,057, #3,010,058, #3,400,477; and #3,400,476)



AUTOCUT®

EASYSTART®

FARM BOSS®

iCademy®

MAGNUM®

MasterWrench Service®

MotoMix®

OILOMATIC®

ROCK BOSS®

STIHL Cutquik®

STIHL DUROMATIC®

STIHL Quickstop®

STIHL ROLLOMATIC®

STIHL WOOD BOSS®

TIMBERSPORTS®

WOOD BOSS®

YARD BOSS®

Some of STIHL's Common Law Trademarks



4-MIX™

BioPlus™

Easy2Start™

EasySpool™

ElastoStart™

Ematic™

FixCut™

HT Plus™

IntelliCarb™

Master Control Lever™

Micro™

Pro Mark™

English

Quad Power ™

Quiet Line ™

STIHL Arctic ™

STIHL Compact ™

STIHL HomeScaper Series ™

STIHL Interchangeable Attachment
Series ™

STIHL M-Tronic ™

STIHL MiniBoss ™

STIHL MotoPlus 4 ™

STIHL Multi-Cut HomeScaper Series ™

STIHL OUTFITTERS ™

STIHL PICCO ™

STIHL PolyCut ™

STIHL PowerSweep ™

STIHL Precision Series ™

STIHL Protech ™

STIHL RAPID ™

STIHL SuperCut ™

STIHL Territory ™

TapAction ™

TrimCut ™

This listing of trademarks is subject to
change.

Any unauthorized use of these
trademarks without the express written
consent of
ANDREAS STIHL AG & Co. KG,
Waiblingen is strictly prohibited.