



# STIHL®

## STIHL HLA 65, 85

Instruction Manual  
Manual de instrucciones



### **WARNING**

Read Instruction Manual thoroughly before use and follow all safety precautions – improper use can cause serious or fatal injury.

### **ADVERTENCIA**

Antes de usar la máquina lea y siga todas las precauciones de seguridad dadas en el manual de instrucciones – el uso incorrecto puede causar lesiones graves o mortales.



**Instruction Manual**

**1 - 35**

**Manual de instrucciones**

**36 - 73**

## Contents

Guide to Using this Manual	2
Safety Precautions and Working Techniques	2
General Power Tool Safety	
Warnings	11
Using the Unit	13
Assembling the Unit	16
Connecting Charger to Power Supply	16
Charging the Battery	17
LEDs on Battery	18
LED on Charger	19
Adjusting the Cutter Bar	20
Adjusting the Telescoping Shaft	21
Fitting the Harness	22
Backpack Carrying System	23
Switching On	24
Switching Off	25
Storing the Machine	25
Sharpening Instructions	26
Maintenance and Care	27
Main Parts	28
Specifications	29
Troubleshooting	31
Maintenance and Repairs	33
Battery Recycling	33
Disposal	33
Trademarks	34
Addresses	35

Allow only persons who fully understand this manual to operate your hedge trimmer.

To receive maximum performance and satisfaction from your STIHL hedge trimmer, it is important that you read, understand and follow the safety precautions and the operating and maintenance instructions in chapter "Safety Precautions and Working Techniques" before using your hedge trimmer. For further information you can go to [www.stihlusa.com](http://www.stihlusa.com).

Contact your STIHL dealer or the STIHL distributor for your area if you do not understand any of the instructions in this manual.

### **WARNING**

Because a hedge trimmer is a high-speed cutting tool, some special safety precautions must be observed to reduce the risk of personal injury. Careless or improper use may cause serious or even fatal injury.

# STIHL®

HLA 65, HLA 85

This instruction manual is protected by copyright. All rights reserved, especially the rights to reproduce, translate and process with electronic systems.

## Guide to Using this Manual

### Pictograms

All the pictograms attached to or embossed on the machine are shown and explained in this manual.

### Symbols in Text

Many operating and safety instructions are supported by illustrations.

The individual steps or procedures described in the manual may be marked in different ways:

- A bullet marks a step or procedure.

A description of a step or procedure that refers directly to an illustration may contain item numbers that appear in the illustration. Example:

- Loosen the screw (1).
- Lever (2) ...

In addition to the operating instructions, this manual may contain paragraphs that require your special attention. Such paragraphs are marked with the following symbols and signal words:

#### **DANGER**

Indicates an imminent risk of severe or fatal injury.

#### **WARNING**

Indicates a hazardous situation which, if not avoided, could result in severe or fatal injury.

### **NOTICE**

Indicates a risk of property damage, including damage to the machine or its individual components.

### Engineering Improvements

STIHL's philosophy is to continually improve all of its products. As a result, engineering changes and improvements are made from time to time. Therefore, some changes, modifications and improvements may not be covered in this manual. If the operating characteristics or the appearance of your machine differs from those described in this manual, please contact your STIHL dealer or the STIHL distributor for your area for assistance.

## Safety Precautions and Working Techniques



Because a hedge trimmer is a high-speed, fast-cutting power tool with sharp cutting blades and is powered by electricity, special safety precautions must be observed to reduce the risk of personal injury.



It is important that you read, fully understand and observe the following safety precautions and warnings. Read the instruction manual and the safety precautions periodically. Careless or improper use may cause serious or fatal injury.

Have your STIHL dealer show you how to operate your power tool. Observe all applicable local safety regulations, standards and ordinances. The use of noise emitting power tools may be restricted to certain times by national or local regulations.

#### **WARNING**

Do not lend or rent your power tool without the instruction manual. Be sure that anyone using it understands the information contained in this manual.

#### **WARNING**

The use of this machine may be hazardous. If the cutting tool comes in contact with your body, it will cut you.

Use your hedge trimmer only for cutting hedges, shrubs, scrub and similar material.

**! WARNING**

Do not use it for other purposes, since misuse may result in personal injury or property damage, including damage to the machine.

**! WARNING**

Minors should never be allowed to use this power tool. Bystanders, especially children, and animals should not be allowed in the area where it is in use.

**! WARNING**

To reduce the risk of injury to bystanders and damage to property, never let your power tool run unattended. When it is not in use (e.g. during a work break), shut it off and make sure that unauthorized persons do not use it. To do this, move retaining latch to  and remove the battery from the power tool.

Most of these safety precautions and warnings apply to the use of all STIHL hedge trimmers. Different models may have different parts and controls. See the appropriate section of your instruction manual for a description of the controls and the function of the parts of your model.

Always remove the battery and move retaining latch to  before transporting, storing or carrying out any work on the power tool. This avoids the risk of the motor starting unintentionally.

STIHL recommends the use of original STIHL replacement parts. They are specifically designed to match your model and meet your performance requirements.

Safe use of a hedge trimmer involves

1. the operator
2. the power tool
3. the use of the power tool.

## THE OPERATOR

### Physical Condition

You must be in good physical condition and mental health and not under the influence of any substance (drugs, alcohol, etc.) which might impair vision, dexterity or judgment. Do not operate this machine when you are fatigued.

**! WARNING**

Be alert – if you get tired, take a break. Tiredness may result in loss of control. Working with any power tool can be strenuous. If you have any condition that might be aggravated by strenuous work, check with your doctor before operating this machine.

**! WARNING**

Prolonged use of a power tool (or other machines) exposing the operator to vibrations may produce whitefinger disease (Raynaud's phenomenon) or carpal tunnel syndrome.

These conditions reduce the hand's ability to feel and regulate temperature, produce numbness and burning sensations and may cause nerve and circulation damage and tissue necrosis.

All factors which contribute to whitefinger disease are not known, but cold weather, smoking and diseases or physical conditions that affect blood vessels and blood transport, as well as high vibration levels and long periods of exposure to vibration are mentioned as factors in the development of whitefinger disease. In order to reduce the risk of whitefinger disease and carpal tunnel syndrome, please note the following:

Most STIHL power tools are available with an anti-vibration ("AV") system designed to reduce the transmission of vibrations created by the machine to the operator's hands. An AV system is recommended for those persons using power tools on a regular or sustained basis.

- Wear gloves and keep your hands warm.
- Keep the AV system well maintained. A power tool with loose components or with damaged or worn AV elements will tend to have higher vibration levels.
- Maintain a firm grip at all times, but do not squeeze the handles with constant, excessive pressure. Take frequent breaks.

All the above-mentioned precautions do not guarantee that you will not sustain whitefinger disease or carpal tunnel syndrome. Therefore, continual and regular users should closely monitor the

## English

condition of their hands and fingers. If any of the above symptoms appear, seek medical advice immediately.

### Proper Clothing

#### **WARNING**

To reduce the risk of injury, the operator should wear proper protective apparel.

#### **WARNING**



To reduce the risk of injury to your eyes never operate your power tool unless wearing goggles or properly fitted protective glasses with

adequate top and side protection complying with ANSI Z87 "+" (or your applicable national standard). Wear an approved safety hard hat when there is a risk of head injury.

STIHL recommends the use of sound barriers (ear plugs or ear muffs) to protect your hearing.



Clothing must be sturdy and snug-fitting but allow complete freedom of movement. Wear long pants made of heavy material to help protect your legs. Do not wear shorts.

Avoid loose-fitting jackets, scarfs, neckties, jewelry, flared or cuffed pants, unconfined long hair or anything that could become caught on branches, brush or the moving parts of the unit. Secure hair so it is above shoulder level.



Good footing is very important. Wear sturdy boots with nonslip soles. Never wear sandals, flip-flops or go barefoot.



Always wear heavy duty work gloves (e.g. made of leather or other wear resistant material) when handling the machine and the cutting tool. Heavy-duty, nonslip gloves improve your grip and help to protect your hands.

### THE POWER TOOL

For illustrations and definitions of the power tool parts see the chapter on "Main Parts."

#### **WARNING**

Never modify this power tool in any way, since this may increase the risk of personal injury. Only attachments supplied by STIHL or expressly approved by STIHL for use with the specific STIHL model are authorized. Although certain unauthorized attachments are useable with STIHL power tools, their use may, in fact, be extremely dangerous.

If your power tool is subjected to unusually high loads for which it was not designed (e.g. heavy impact or a fall), always check that it is in good condition before continuing work – see also "Before Starting Work." Make sure the safety devices are working properly. Do not continue operating your power tool if

it is damaged. In case of doubt, have the machine checked by your STIHL servicing dealer.

### Battery

#### **WARNING**



Risk of fire, explosion and/or burns, including chemical burns. Do not disassemble, crush, heat above 212 °F (100 °C), expose to fire or incinerate. Never expose the battery to microwaves or high pressures.

Do not place the battery on or near fires, stoves or in other high-temperature locations. Do not place the battery in direct sunlight or store it inside a vehicle in hot weather. Doing so may cause the battery to generate heat, rupture or ignite. Using the batteries in this manner may also result in a loss of performance and a shortened battery life.

In case of fire: stay clear of any vapors or gases generated, taking wind direction into account. If possible without danger, remove battery from the vicinity of the fire. In principle, cooling the battery or extinguishing the fire with water is possible. It is preferable to extinguish the fire with a multipurpose dry chemical fire extinguisher. As for any fire, evacuate the area and fight the fire from a safe distance. Once the fire has been extinguished, the area should be monitored (fire watch) in case of a flare-up, until the battery has cooled sufficiently. Restrict access to the area until completion of clean-up. Do not

touch the burnt battery or any spilled liquids. Use inert absorbent to absorb spilled liquids.



Use and store the battery only within a temperature range from 14 °F (-10 °C) up to no more than 122 °F (+ 50 °C). Protect the battery from direct sunlight.

### WARNING

Use STIHL batteries only with STIHL power tools, and charge them only with STIHL chargers. Replace battery with STIHL battery only. Use only genuine STIHL rechargeable batteries.

Charge the battery before use.



Do not immerse the battery in fluids.

### WARNING

Do not open, drop, hit or damage battery. Never insert objects into the battery's cooling slots, since they may damage the battery. The battery contains safety features and devices which, if damaged, may cause the battery to generate heat, rupture or ignite. Never use or charge a defective, damaged, cracked or deformed battery.

Immediately discontinue use of the battery if, while using, charging or storing, it emits an unusual smell, feels hot or appears abnormal in any other way.

### WARNING

Fluid may leak from the battery if it is damaged or is not used properly – avoid contact with the skin! Leaking battery fluid can cause skin irritation and chemical burns. In the event of accidental contact, immediately rinse thoroughly with mild soap and water. If fluid gets into your eye(s), do not rub your eye(s) but rinse water over the open eye(s) for 15 minutes at least. Also seek medical attention immediately.

### WARNING

Never bridge (short circuit) the battery terminals with metallic objects, since this may damage the battery and possibly cause a fire. Keep a battery that is not in use away from metal objects (e.g. nails, coins, jewelry). Do not use metal containers for transporting batteries.

Store the battery out of reach of children in a cool and dry area away from direct sunlight and excess heat or cold (14 °F – 122 °F (-10 °C – +50 °C)).

### Charger

Use only original STIHL chargers.

Use only for charging geometrically matching STIHL batteries with a maximum capacity of 50 Ah and a maximum voltage of 42 V.

Never charge defective, leaking or deformed batteries.

Connect the charger only to a power supply with the voltage and frequency specified on the rating plate. Always plug the charger into a properly installed

wall outlet. Do not use an extension cord unless absolutely necessary (see below).

Never use a charger with damaged housing, damaged power supply cord or damaged plug. Do not operate the charger if it has received a sharp blow, been dropped or otherwise damaged in any way.

Do not open or disassemble charger – there are no user serviceable parts inside.

Store charger out of the reach of children.



Protect the charger from rain and dampness. Keep charger dry.



Use and store charger only indoors in dry rooms.

Operate charger at temperatures between 41 °F (5 °C) and 104 °F (40 °C).

Allow the charger to cool down normally – do not cover it.

Never bridge the contacts of the charger with metallic objects (e.g. nails, coins, jewelry) – short circuit. The charger will be damaged by a short circuit.

In the event of smoke or fire in the charger, disconnect it from outlet immediately.

**! WARNING**

To reduce the risk of electric shock or short circuit, do not insert any objects into the charger's cooling slots.

**! WARNING**

The charger heats up during the charging process. Do not operate on an easily combustible surface (e.g. paper, cardboard, textiles) or in an easily combustible environment – risk of fire.

**! WARNING**

Do not operate in a hazardous location, i.e. in a location where there are combustible liquids (fumes), vapors or dusts. Chargers can produce sparks, which may ignite the dust or vapors – risk of explosion.



Check the charger's power supply cord and plug regularly for damage. If the power supply cord or plug is damaged, immediately disconnect the plug from the wall outlet to avoid the risk of electric shock.

Never jerk the power supply cord to disconnect it from the wall outlet. To unplug, grasp the plug, not the cord. Have a damaged power supply cord repaired by an experienced electrician.

Do not use the power supply cord for any other purpose, e.g. for carrying or hanging up the charger.

Never use power supply cords that do not comply with regulations.

Make sure the power supply cord is located and/or marked so that it will not be stepped on, tripped over, come in contact with sharp edges or moving parts or otherwise be subjected to damage or stress.

An extension cord should not be used unless absolutely necessary. If an extension cord must be used, plug the charger into a properly wired 16 gauge (AWG 16) or heavier gauge extension cord with blades that are the same number, size and shapes as the blades on the charger.

To reduce the risk of electric shock:

- Always connect the unit to a properly installed wall outlet.
- Make sure the insulation of the power supply cord and plug is in good condition.

Unplug the power supply cord from the outlet when charger is not in use.

Never store a battery in the charger.

**THE USE OF THE POWER TOOL**



Remove the battery from the power tool before:

- carrying out tests and adjustments or cleaning work
- working on the cutting attachment
- leaving the power tool unattended
- transporting the power tool
- storing the power tool

- performing repairs and maintenance work
- in the event of danger or in an emergency

**Transporting the Unit**

**! WARNING**

To reduce the risk of injury from blade contact, never carry or transport your power tool with the cutting blades moving.

**! WARNING**

Always switch off the power tool, move retaining latch to , remove the battery and fit the scabbard over the cutting blades – even when you carry the unit for short distances. When transporting it in a vehicle, properly secure the power tool to prevent turnover and damage.



Remove the battery from the power tool. This avoids the risk of the motor starting unintentionally.

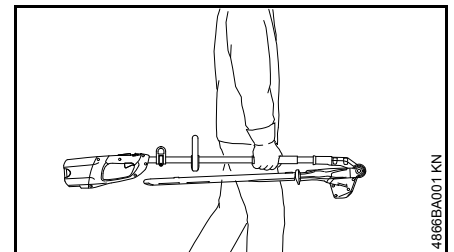

Grip the shaft in a manner that the machine is balanced horizontally.



## Before Starting Work

### **!** WARNING

Always check your power tool for proper condition and operation before starting, particularly the trigger switch, trigger switch lockout, switch lever and retaining latch. The trigger switch, trigger switch lockout and switch lever must move freely and always spring back to the idle position (retaining latch on ). Never attempt to modify the controls or safety devices.

### **!** WARNING

Your power tool is equipped with a system designed to quickly stop the cutting blades – they come to an immediate standstill as soon as you release the trigger switch and/or the switch lever on the loop handle.

Check this function at regular short intervals. To reduce the risk of injury, do not operate your power tool if the cutting blades continue to run. Contact your servicing dealer.

### **!** WARNING

Never use a power tool that is damaged or not properly maintained.

Keep the handles clean and dry at all times; it is particularly important to keep them free of moisture, pitch, oil, grease or resin in order for you to maintain a firm grip and properly control your power tool.

### **!** WARNING

The cutting blades must be properly tightened and in safe operating condition. Inspect for loose parts (nuts, screws, etc.) and for cracked, bent, warped or damaged blades. Regularly check the condition and tightness of the cutting blades – with the motor stopped, retaining latch on  and battery removed! Replace damaged cutting blades before using the power tool. Always keep blades sharp.

STIHL recommends that you always spray the cutting blades with STIHL resin solvent before starting work – with the motor stopped, retaining latch on  and battery removed! You can obtain this protective spray from your dealer. Apply generously.

Check contacts in battery compartment for foreign matter. Keep clean.

Fit the battery correctly – it must engage audibly.

For specific starting instructions, see the appropriate section of your instruction manual.

### **!** WARNING

To reduce the risk of injury from blade contact, be absolutely sure that the cutting blades are clear of you and all other obstructions and objects, including the ground.

### **!** WARNING

Your power tool is a one-person machine. Do not allow other persons in the general work area, even when starting.

## During Operation

### Holding and Controlling the Power Tool (Version without Telescoping Shaft)

Always hold the unit firmly with both hands on the handles while you are working. Wrap your fingers and thumbs around the handles.

#### Right-Handers

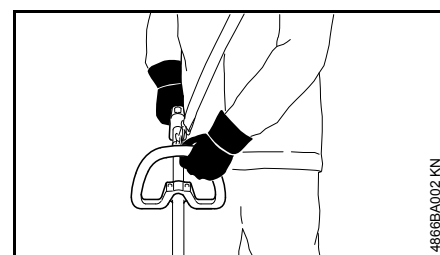

Right hand on the control handle and left hand on the loop handle or handle hose on the drive tube.

#### Left-Handers

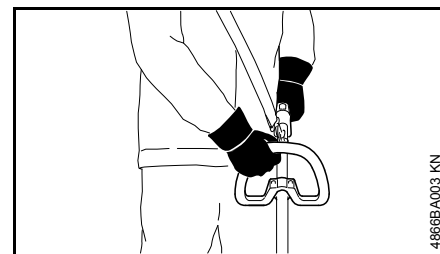

Left hand on the control handle and right hand on the loop handle or handle hose on the drive tube.

Make sure you have firm and secure footing and hold the unit so that the cutting blades are always away from your body.

English

### Harness

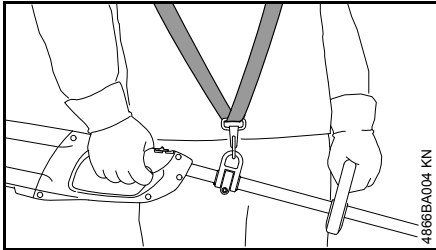

The machine can be carried on a harness to relieve the weight on the operator's arms.

### Holding and Controlling the Power Tool (Version with Telescoping Shaft)

Always hold the unit firmly with both hands on the handles while you are working. Wrap your fingers and thumbs around the handles.

### Right-Handers



Right hand on the control handle and left hand on the handle hose on the drive tube.

### Left-Handers

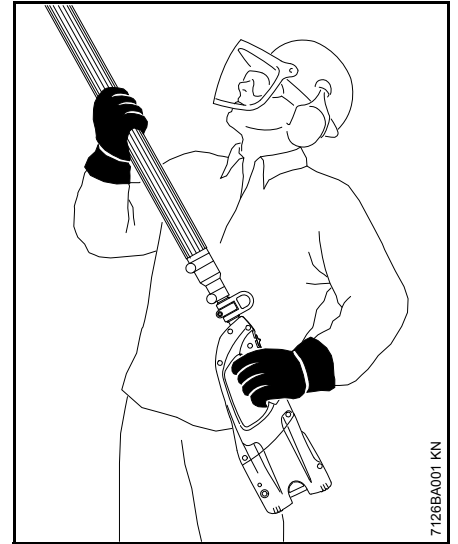

Left hand on the control handle and right hand on the handle hose on the drive tube.

Make sure you have firm and secure footing and hold the unit so that the cutting blades are always away from your body.

### Harness

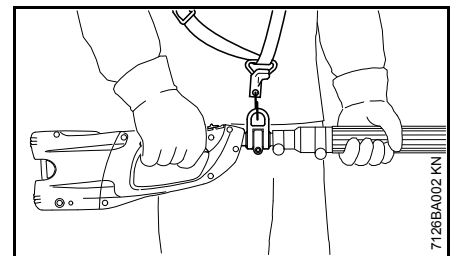

The machine can be carried on a harness to relieve the weight on the operator's arms.

**! WARNING**

Never attempt to operate your power tool with one hand. Loss of control of the power tool resulting in serious or fatal injury may result. To reduce the risk

of cut injuries, keep hands and feet away from the cutting blades. Never touch moving cutting blades with your hand or any other part of your body. Do not touch the cutting blades while the motor is running. If the cutting blades become jammed by thick branches or other obstructions, switch off the motor immediately, move retaining latch to  and remove the battery before attempting to free the blades.

**! WARNING**

Do not overreach. Keep proper footing and balance at all times. Special care must be taken in slippery conditions (wet ground, snow) and in difficult, overgrown terrain. Watch for hidden obstacles such as tree stumps, roots and ditches to avoid stumbling. For better footing, clear away fallen branches, scrub and cuttings. Be extremely cautious when working on slopes or uneven ground.

**Working Conditions**

Operate your power tool only under good visibility and daylight conditions only. Work carefully.

Do not cut any material other than hedges or similar soft vegetation. Do not cut stems greater than 17 mm (11/16 inch) thick.

**! WARNING**

If the vegetation being cut or the surrounding ground is coated with a chemical substance (such as an active pesticide or herbicide), read and follow the instructions and warnings that accompanied the substance at issue.

**! WARNING**

Inhalation of certain dusts, especially organic dusts such as mold or pollen, can cause susceptible persons to have an allergic or asthmatic reaction. Substantial or repeated inhalation of dust and other airborne contaminants, in particular those with a smaller particle size, may cause respiratory or other illnesses. Control dust at the source where possible. Use good work practices, such as operating the unit so that the wind or operating process directs any dust raised by the power tool away from the operator. Follow the recommendations of EPA/OSHA /NIOSH and occupational and trade associations with respect to dust ("particulate matter"). When the inhalation of dust cannot be substantially controlled, i.e., kept at or near the ambient (background) level, the operator and any bystanders should wear a respirator approved by NIOSH/MSHA for the type of dust encountered.

If the hedge is very dusty or dirty, spray the blades with STIHL resin solvent from time to time during cutting. This helps reduce blade friction as well as the aggressive effects of sap and the build-up of dirt particles.

**Operating Instructions****! WARNING**

In the event of an emergency, switch off the motor immediately, move retaining latch to  and remove the battery.

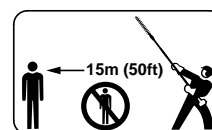

The power tool has a large range. In order to reduce the risk of personal or even fatal injury to bystanders from

falling objects or inadvertent contact with the moving cutter blades of your power tool always keep bystanders at least 50 feet (15 m) away when the power tool is running.

**! WARNING**

Before you start work, examine the hedge area for stones, fence wire, metal or other solid objects which could damage the cutting blades.

Take particular care when cutting hedges next to or against wire fences. Do not touch the wire with the cutting blades. When working close to the ground, make sure that no sand, grit or stones get between the cutting blades.

Striking solid foreign objects such as stones, fence wire or metal could damage the cutting attachment and may cause blades to crack, chip or break. STIHL does not recommend the use of your power tool when cutting in areas where the blades could contact such objects.

**! WARNING**

Observe the cutting blades at all times – do not cut any areas of the hedge that you cannot see. When cutting the top of a taller hedge, check the other side of the hedge frequently for bystanders, animals and obstructions. Do not damage the property of other persons

**! WARNING**



Do not rely on the tool's insulation against electric shock. To reduce the risk of electrocution, never operate this power tool in the vicinity of any wires or

cables (power, etc.) which may be carrying electric current.

Check the cutting blades at regular short intervals during operation, or immediately if there is a noticeable change in cutting behavior:

- Switch off the motor.
- Move retaining latch to .
- Remove the battery.
- Check condition and tightness, look for cracks.
- Check sharpness.
- Replace damaged or dull cutting blades immediately, even if they have only superficial cracks.

The power tool may be used in rain and wetness. Dry the power tool after finishing work.

Your power tool is equipped with a system designed to quickly stop the cutting blades – they come to an

immediate standstill as soon as you release the trigger switch and/or the switch lever on the loop handle.

**! WARNING**

To reduce the risk of injury from loss of control, never work on a ladder, in a tree or any other insecure support. Never hold the machine above shoulder height.

Be particularly alert and cautious when wearing hearing protection because your ability to hear warnings (shouts, alarms, etc.) is restricted.

**! WARNING**

To reduce the risk of fire, always clean plant residue, chips, leaves and excess lubricant off the motor.

#### After Finishing Work

Always clean dust and dirt off the power tool – do not use any grease solvents for this purpose.

Spray the blades with STIHL resin solvent. Run the motor briefly so that the solvent is evenly distributed.

#### MAINTENANCE, REPAIR AND STORING

**If you make a warranty claim for a component which has not been serviced or maintained properly or if nonapproved replacement parts were used, STIHL may deny coverage.**

**! WARNING**

Use only identical STIHL replacement parts for maintenance and repair. Use of non-STIHL parts may cause serious or fatal injury.

Strictly follow the maintenance and repair instructions in the appropriate section of your instruction manual. Please also refer to the maintenance chart in this manual.



Always move retaining latch to  and remove the battery from the power tool before carrying out any repairs or maintenance work, such as replacing the cutting blades. This avoids the risk of the motor starting unintentionally.

**! WARNING**

Always switch off the motor, move retaining latch to , remove the battery and make sure that the cutting tool is stopped before doing any maintenance or repair work or cleaning the power tool. Do not attempt any maintenance or repair work not described in your instruction manual. Have such work performed by your STIHL servicing dealer only.

Wear gloves when handling or performing maintenance on the blades.

## WARNING

Never repair damaged cutting attachments by welding, straightening or modifying the shape. This may cause parts of the cutting blades to come off and result in serious or fatal injuries.

Keep the cutting blades sharp. Tighten all nuts, bolts and screws after each use.

Regularly check the electrical contacts and ensure that the insulation of the power cord and plug of the charger is in good condition and show no sign of aging (brittleness).

Electrical components, e.g. power cord of charger, may only be repaired or replaced by a qualified electrician.

Clean plastic components with a cloth. Do not use aggressive detergents. They may damage the plastic.

Do not spray the machine with water.

Do not clean your machine with a pressure washer. The solid jet of water may damage parts of the machine.

Clean cooling air inlets in motor housing as necessary.

Keep the battery guides free from foreign matter – clean as necessary.

Store the power tool in a dry, locked location with the retaining latch on , the battery removed and out of reach of children.

## General Power Tool Safety Warnings

This chapter relays the prescribed wording of general safety advice for handheld motor-operated electric hedge trimmers contained in UL 60745-1 and UL 60745-2-15.

The safety precautions and warnings on avoiding an electric shock given under "2) Electrical safety" do not apply to STIHL cordless electric power tools.

## WARNING

**Read all safety warnings and all instructions.** Failure to follow the warnings and instructions may result in electric shock, fire and/or serious injury.

**Save all warnings and instructions for future reference.**

The term "power tool" in the warnings refers to your mains-operated (corded) power tool or battery-operated (cordless) power tool.

### 1) Work area safety

- a) **Keep work area clean and well lit.** Cluttered or dark areas invite accidents.
- b) **Do not operate power tools in explosive atmospheres, such as in the presence of flammable liquids, gases or dust.** Power tools create sparks which may ignite the dust or fumes.
- c) **Keep children and bystanders away while operating a power tool.** Distractions can cause you to lose control.

### 2) Electrical safety

- a) **Power tool plugs must match the outlet. Never modify the plug in any way. Do not use any adapter plugs with earthed (grounded) power tools.** Unmodified plugs and matching outlets will reduce risk of electric shock.
- b) **Avoid body contact with earthed or grounded surfaces such as pipes, radiators, ranges and refrigerators.** There is an increased risk of electric shock if your body is earthed or grounded.
- c) **Do not expose power tools to rain or wet conditions.** Water entering a power tool will increase the risk of electric shock.
- d) **Do not abuse the cord. Never use the cord for carrying, pulling or unplugging the power tool. Keep cord away from heat, oil, sharp edges or moving parts.** Damaged or entangled cords increase the risk of electric shock.
- e) **When operating a power tool outdoors, use an extension cord suitable for outdoor use.** Use of a cord suitable for outdoor use reduces the risk of electric shock.
- f) **If operating a power tool in a damp location is unavoidable, use a residual current device (RCD) protected supply.** Use of an RCD reduces the risk of electric shock.

### 3) Personal safety

- a) **Stay alert, watch what you are doing and use common sense when operating a power tool. Do not use a power tool while you are tired or under the influence of drugs, alcohol or medication.** A moment of inattention while operating power tools may result in serious personal injury.
  - b) **Use personal protective equipment. Always wear eye protection.** Protective equipment such as dust mask, non-skid safety shoes, hard hat, or hearing protection used for appropriate conditions will reduce personal injuries.
  - c) **Prevent unintentional starting. Ensure the switch is in the off-position before connecting to power source and/or battery pack, picking up or carrying the tool.** Carrying power tools with your finger on the switch or energizing power tools that have the switch on invites accidents.
  - d) **Remove any adjusting key or wrench before turning the power tool on.** A wrench or a key left attached to a rotating part of the power tool may result in personal injury.
  - e) **Do not overreach. Keep proper footing and balance at all times.** This enables better control of the power tool in unexpected situations.
  - f) **Dress properly. Do not wear loose clothing or jewelry. Keep your hair, clothing and gloves away from moving parts.** Loose clothes, jewelry or long hair can be caught in moving parts.
  - g) **If devices are provided for the connection of dust extraction and collection facilities, ensure these are connected and properly used.** Use of dust collection can reduce dust-related hazards.
- ### 4) Power tool use and care
- a) **Do not force the power tool. Use the correct power tool for your application.** The correct power tool will do the job better and safer at the rate for which it was designed.
  - b) **Do not use the power tool if the switch does not turn it on and off.** Any power tool that cannot be controlled with the switch is dangerous and must be repaired.
  - c) **Disconnect the plug from the power source and/or the battery pack from the power tool before making any adjustments, changing accessories, or storing power tools.** Such preventive safety measures reduce the risk of starting the power tool accidentally.
  - d) **Store idle power tools out of the reach of children and do not allow persons unfamiliar with the power tool or these instructions to operate the power tool.** Power tools are dangerous in the hands of untrained users.
  - e) **Maintain power tools. Check for misalignment or binding of moving parts, breakage of parts and any other condition that may affect the power tool's operation. If damaged, have the power tool repaired before use.** Many accidents are caused by poorly maintained power tools.
  - f) **Keep cutting tools sharp and clean.** Properly maintained cutting tools with sharp cutting edges are less likely to bind and are easier to control.
  - g) **Use the power tool, accessories and tool bits etc. in accordance with these instructions, taking into account the working conditions and the work to be performed.** Use of the power tool for operations different from those intended could result in a hazardous situation.
- ### 5) Battery tool use and care
- a) **Recharge only with the charger specified by the manufacturer.** A charger that is suitable for one type of battery pack may create a risk of fire when used with another battery pack.
  - b) **Use power tools only with specifically designated battery packs.** Use of any other battery packs may create a risk of injury and fire.

- c) When battery pack is not in use, keep it away from other metal objects, like paper clips, coins, keys, nails, screws or other small metal objects, that can make a connection from one terminal to another. Shorting the battery terminals together may cause burns or a fire.
- d) Under abusive conditions, liquid may be ejected from the battery; avoid contact. If contact accidentally occurs, flush with water. If liquid contacts eyes, additionally seek medical help. Liquid ejected from the battery may cause irritation or burns.

## 6) Service

---

- a) Have your power tool serviced by a qualified repair person using only identical replacement parts. This will ensure that the safety of the power tool is maintained.

## Hedge Trimmer Safety Warnings

---

- Keep all parts of the body away from the cutter blade. Do not remove cut material or hold material to be cut when blades are moving. Make sure the switch is off when

clearing jammed material. Blades coast after turn off. A moment of inattention while operating the hedge trimmer may result in serious personal injury.

- Carry the hedge trimmer by the handle with the cutter blade stopped. Proper handling of the hedge trimmer will reduce possible personal injury from the cutter blades.
- Hold the power tool by insulated gripping surfaces only, because the cutter blade may contact hidden wiring. Cutter blades contacting a "live" wire may make exposed metal parts of the power tool "live" and could give the operator an electric shock.



### DANGER

- Keep hands away from blade. Contact with blade will result in serious personal injury.

## Using the Unit

### Cutting Season

---

Observe country-specific or municipal rules and regulations for cutting hedges.

Do not use your hedge trimmer during rest periods customary in the neighborhood.

### Cutting Sequence

---

If a radical cut is necessary, cut a little at a time in several stages.

Use lopping shears to cut out thick branches first.

Cut the sides of the hedge first, then the top.

### Disposal

---

Do not throw cuttings into the garbage can – they can be composted.

### Preparations

---

- Adjust angle of cutter bar – see "Adjusting the Cutter Bar"
- Remove the blade scabbard.
- Put on the harness – see "Fitting the Harness".
- Connect machine to harness – see "Fitting the Harness".

### Working Technique

Observe the following sections in the chapter on "Safety Precautions and Working Techniques":

- Holding and Controlling the Unit (Version without Telescoping Shaft)
- Holding and Controlling the Unit (Version with Telescoping Shaft)

### Horizontal Cut (with cutter bar at an angle)



Cutting close to the ground from a standing position, e.g. low shrubs.

Swing the cutter bar back and forth in an arc as you move along – use both sides of the cutting blades.

The hedge trimmer is unsuitable for mowing.

### Vertical Cut (with cutter bar at an angle)



Cutting without standing directly next to the hedge, e.g. flowerbed between operator and hedge.

Swing the cutter bar up and down in an arc as you move along the hedge – use both sides of the cutting blades.

### Vertical Cut (with straight cutter bar)

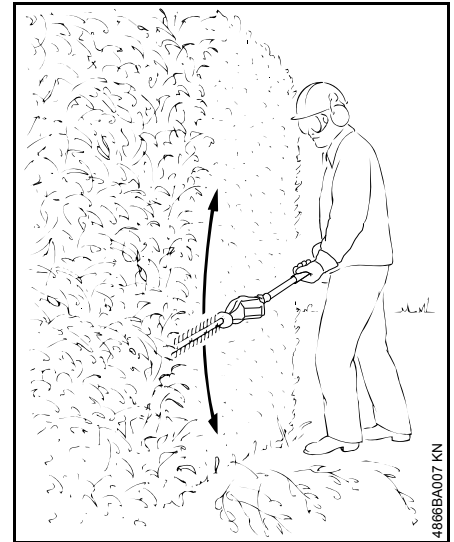

Extra long reach without the need for other aids.

Swing the cutter bar up and down in an arc as you move along the hedge – use both sides of the cutting blades.



### Overhead Cut (with cutter bar at an angle)

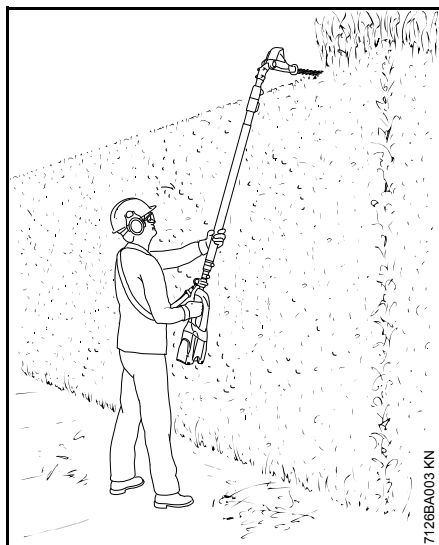

Hold the hedge trimmer vertically and swing it in an arc to make maximum use of its reach.

### **!** WARNING

Any working position above head height is tiring. To minimize the risk of accidents, work in such positions for short periods only. Set angle of adjustable cutter bar to maximum so that the unit can be held in a lower, less tiring position (with shoulder strap) while still providing adequate reach.

### Horizontal Cut (with straight cutter bar)

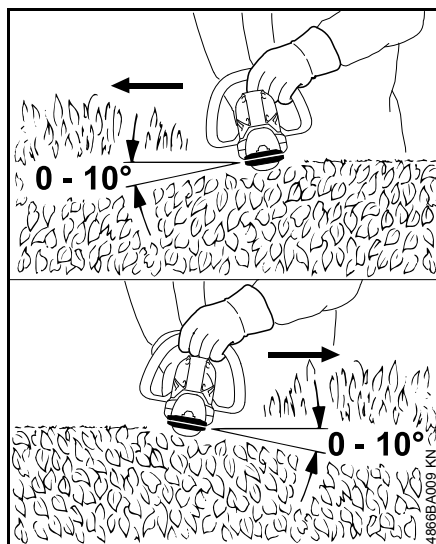

Hold the cutter bar at an angle of  $0^{\circ}$  to  $10^{\circ}$  as you swing the hedge trimmer horizontally.

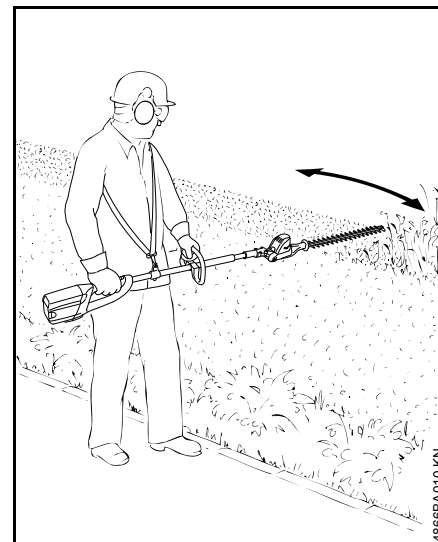

Swing the cutter bar in an arc towards the outside of the hedge so that the cuttings are swept to the ground.

## Assembling the Unit

### Mounting the loop handle

Only versions without telescoping shaft

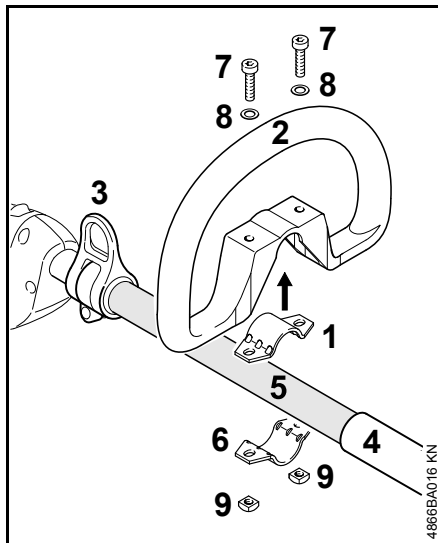

- Place the clamp (1) in the loop handle (2) and position them both against the shaft (5) between the carrying ring (3) and handle hose (4).
- Position the clamp (6) against the shaft.
- Line up the holes.
- Insert the screws (7) with washers (8).
- Fit the square nuts (9) and screw home the screws.

- Line up the loop handle.
- Tighten down the screws firmly.

## Connecting Charger to Power Supply

Power supply (mains) voltage and operating voltage must be the same.

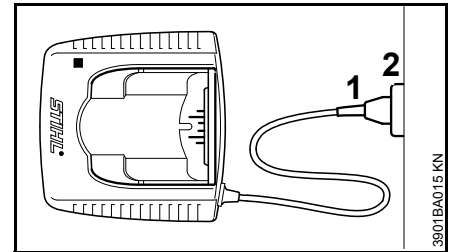

- Insert the plug (1) in the wall outlet (2).

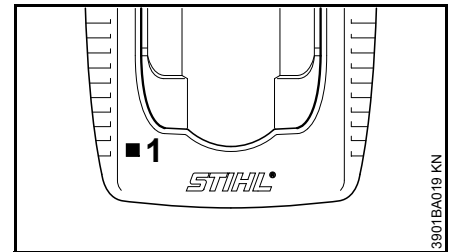

A self test is performed after the charger is connected to the power supply. During this process, the light emitting diode (1) on the charger lights up green for about 1 second, then red and goes off again.

## Charging the Battery

When delivered, the battery is not fully charged.

It is advisable to charge the battery completely before using it for the first time.

- Connect the charger to the power supply – mains voltage and operating voltage of the charger must be the same – see "Connecting Charger to Power Supply".

Operate the charger only in a closed, dry space at ambient temperatures between 41 °F (5 °C) and 104 °F (40 °C).

Only charge dry batteries. Allow a damp battery to dry before charging.

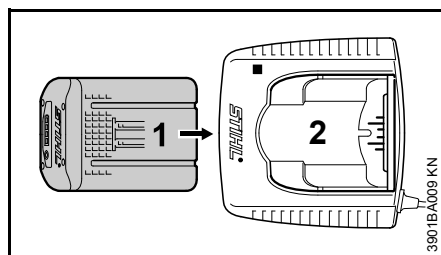

- Slide the battery (1) into the charger (2) until you start to feel resistance – then push it in until it engages.

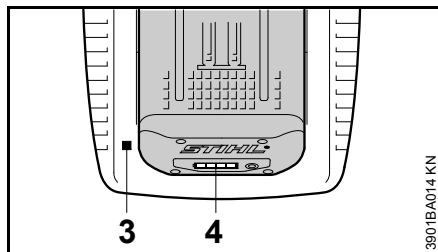

The LED (3) on the charger comes on when the battery is inserted – see "LED on Charger"

Charging begins as soon as the LEDs (4) on the battery glow green – see "LEDs on Battery".

Charge time depends on a number of factors, including battery condition, ambient temperature, etc., and may therefore vary from the times specified.

The battery heats up during operation in the power tool. If a hot battery is inserted in the charger, it may be necessary to cool it down before charging. The charging process begins only after the battery has cooled down. The time required for cooling may prolong the charge time.

The battery and charger heat up during the charging process.

### AL 300, AL 500 Chargers

The AL 300 and AL 500 chargers are equipped with a battery cooling fan, which can be heard during operation.

### AL 100 Charger

The AL 100 charger has no fan and waits for the battery to cool down before starting the charging process. The battery is cooled by heat dissipation in the ambient air.

### End of Charge

The charger switches itself off automatically when the battery is fully charged:

- LEDs on the battery go off.
- The LED on the charger goes off.
- The charger's fan is switched off (if charger is so equipped).

Remove the fully charged battery from the charger.



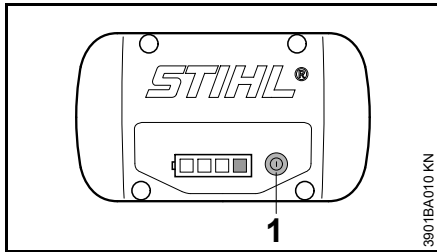

## LEDs on Battery

Four LEDs show the battery's state of charge and any problems that occur on the battery or power tool.



- Press button (1) to activate the display – the display goes off automatically after 5 seconds.

The LEDs can glow or flash green or red.

-  LED glows continuously green.
-  LED flashes green.
-  LED glows continuously red.
-  LED flashes red.

### During Charging Process

The LEDs glow continuously or flash to indicate the progress of charge.

A green flashing LED indicates the capacity that is currently being charged.

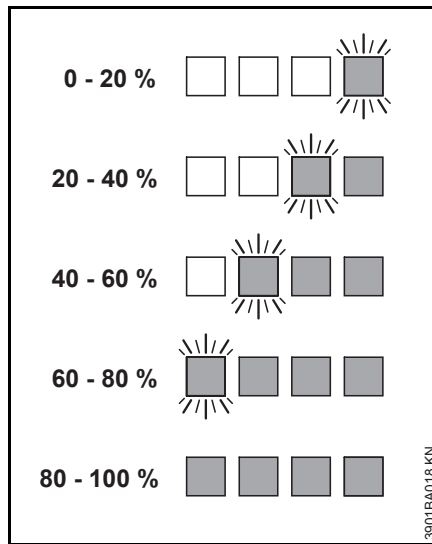

The LEDs on the battery go off automatically when the charge process is completed.

If the LEDs on the battery flash or glow red – see "If the red LEDs glow continuously / flash".

### During Operation

The green LEDs glow continuously or flash to indicate the state of charge.

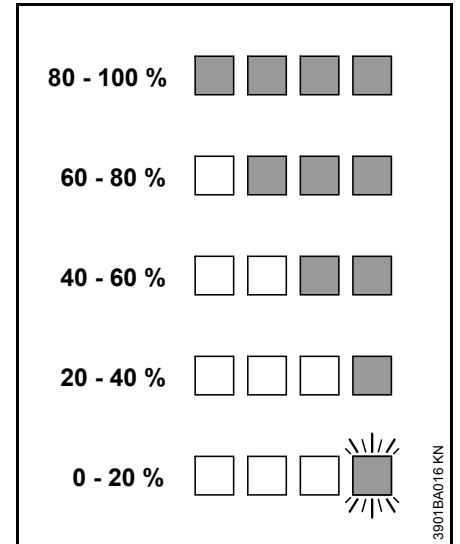

If the LEDs on the battery flash or glow red – see "If the red LEDs glow continuously / flash".

**If the red LEDs glow continuously / flash**

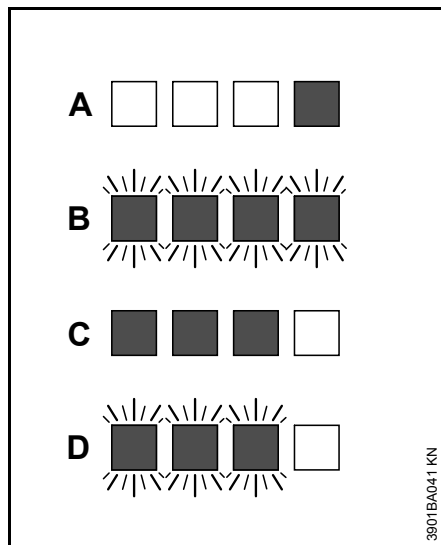

A	1 LED glows continuously red:	Battery is too hot <sup>1)</sup> 2)/cold <sup>1)</sup>
B	4 LEDs flash red	Malfunction in battery <sup>3)</sup>
C	3 LEDs glow continuously red:	Power tool is too hot – allow it to cool down.
D	3 LEDs flash red	Malfunction in power tool <sup>4)</sup>

- 1) When charging: Charge process starts automatically after the battery has cooled down / warmed up.
- 2) During operation: Power tool cuts out – allow battery to cool down; it may be necessary to take the battery out of the power tool for this purpose.

- 3) Electromagnetic interference or fault. Take the battery out of the power tool and refit it. Switch on the machine – if the LEDs continue to flash, the battery has a malfunction and must be replaced.
- 4) Electromagnetic interference or fault. Take the battery out of the machine. Use a blunt tool to remove dirt from the contacts in the battery compartment. Refit the battery. Switch on the power tool – if the LEDs still flash, the power tool has a malfunction and must be checked by a servicing dealer – STIHL recommends an authorized STIHL servicing dealer.

**LED on Charger**

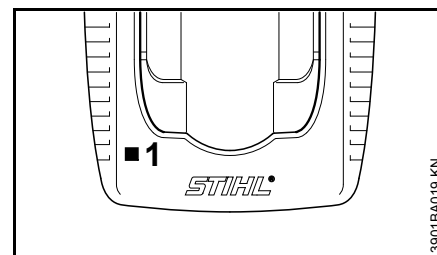

The LED (1) on the charger may glow continuously green or flash red.

**Green continuous light ...**

... indicates the following:

The battery

- is being charged
- is too hot and must cool down before charging

See also "LEDs on battery".

The green LED on the charger goes off as soon as the battery is fully charged.

**Red flashing light ...**

... may indicate the following:

- No electrical contact between battery and charger – remove and refit the battery
- Malfunction in battery – see also "LEDs on Battery".
- Malfunction in charger – have checked by a servicing dealer. STIHL recommends an authorized STIHL servicing dealer.

## Adjusting the Cutter Bar

### Angle Adjuster - 115°

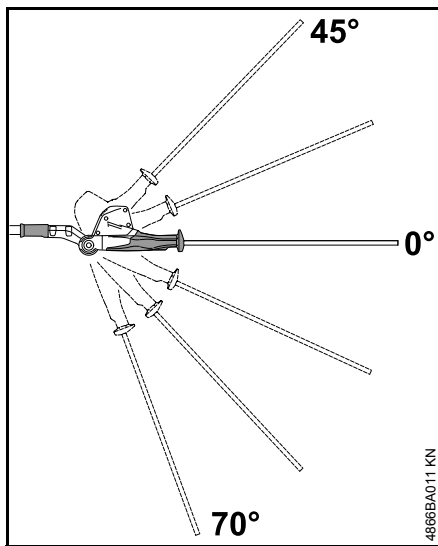

The angle of the cutter bar can be adjusted upwards in 2 stages from 0° (straight) to 45°, and downwards in 3 stages from 0° to 70°. There are therefore 6 possible working positions.

There is also a special transport position for the cutter bar – see section on "Transport Position".

### **!** WARNING

To reduce the risk of injury, make adjustment only with cutting blades at a standstill – machine switched off, retaining latch set to .

### **!** WARNING

The gearbox becomes hot during operation. To reduce the risk of burn injury, do not touch the gear housing.

### **!** WARNING

To reduce the risk of injury, never touch the blades while making adjustments.

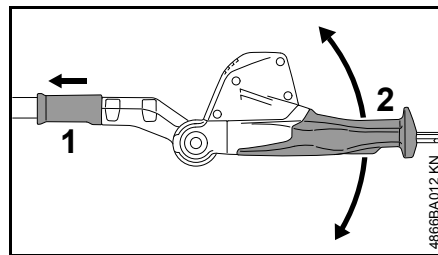

- Switch off the machine and set the retaining latch to .
- Pull back the sliding sleeve (1) and use the swivel handler (2) to adjust the joint by one or several holes.
- Release the sliding sleeve (1) and make sure the lock pin engages the quadrant.

The sliding sleeve butts against the housing when the pin is properly engaged (after making adjustment).

### **!** WARNING

Never use the swivel handle for normal cutting operations – risk of injury.

## Transport Position

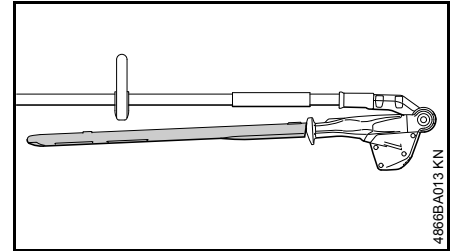

The cutter bar can be folded flat against the drive tube and locked in position to save space during transportation. Your machine cannot be switched on while it is in the transport position.

### **!** WARNING

To reduce the risk of injury, always switch off the machine – retaining latch to  – remove the battery and fit the blade scabbard before moving the cutter blade into the transport position or from the transport position to the normal operating position.

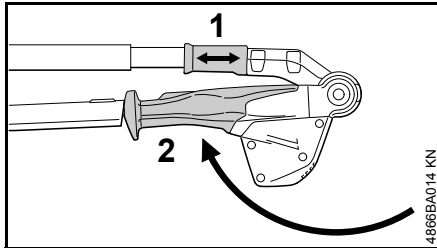

- Switch off the machine, move the retaining latch to  and remove the battery.
- Fit the blade scabbard.
- Pull back the sliding sleeve (1) and use the swivel handle (2) to swing the joint downwards – in direction of drive tube – until the cutter bar is flat against the drive tube.
- Release the sliding sleeve (1) and allow lock pin to engage the hole in the housing.

The sliding sleeve butts against the housing when the pin is properly engaged (after making adjustment).

## Adjusting the Telescoping Shaft

HLA 85 only



### WARNING

Always switch off the power tool and move the retaining latch to .

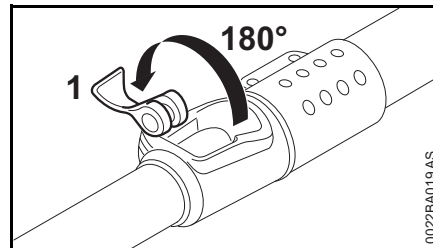

- Open lever (1) of quick-release clamp and swing it back as far as it will go.

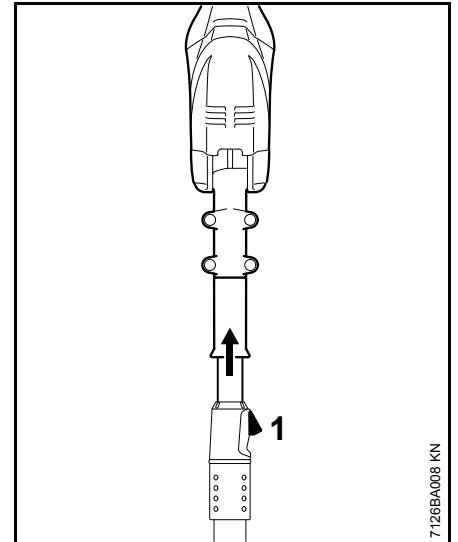

- Adjust shaft to the required length.
- Close the lever (1) and press it down as far as stop.
- Check clamping force – if it is too low: go to "Adjusting Clamping Force".

The clamping force is correct when the shaft is firmly locked in position with the quick-release clamp closed.

### Adjusting clamping force

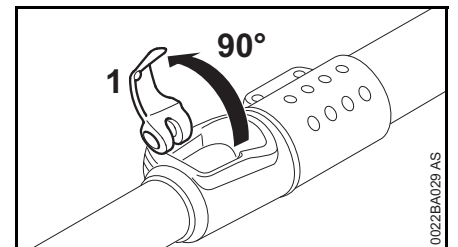

- Swing lever (1) of quick-release clamp up to 90° position.

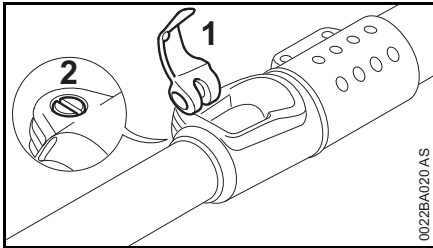

- Turn screw (2) slowly clockwise as far as stop – the lever must move freely to closed position. If not, the clamping force is too high.
- Close lever (1) and press it home as far as stop – the clamping force is too high if the lever does not locate against the stop.
- Check clamping force.

If clamping force is too low:

- Carefully turn screw (2) clockwise a 1/4 turn at a time – this increases the clamping force.

If clamping force is too high:

- Carefully turn screw (2) counterclockwise a 1/4 turn at a time – this reduces the clamping force.

## Fitting the Harness

The type of harness is market-specific.

### Shoulder Strap

#### Versions without telescoping shaft

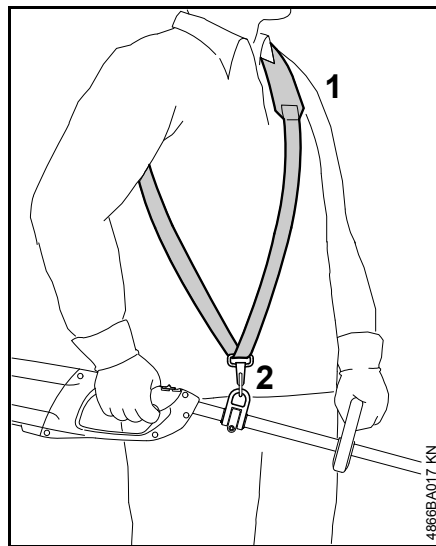

- Put on the shoulder strap (1).
- Adjust the length of the strap so that the carabiner (2) is about a hand's width below your right hip.

#### Versions with telescoping shaft

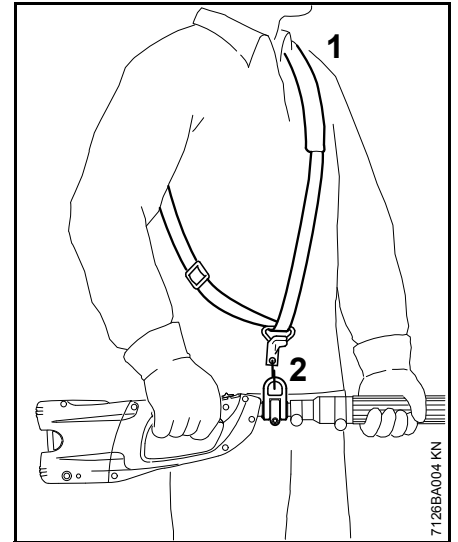

- Put on the shoulder strap (1).
- Adjust the length of the strap so that the carabiner (2) is about a hand's width below your right hip.

### Attaching Machine to Harness

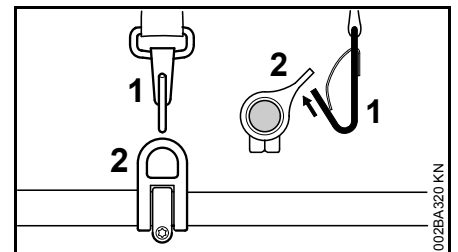

- Attach the carabiner (1) to the carrying ring (2) on the drive tube.



### Detaching Machine from Harness

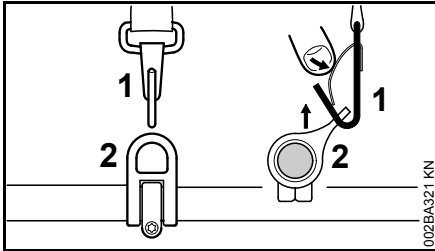

- Press down the bar on the carabiner (1) and pull the carrying ring (2) out of the carabiner.

### Backpack Carrying System

The backpack carrying system is a special accessory for machines with a telescoping shaft.

It spreads the weight of machine evenly over the shoulders, back and hips.

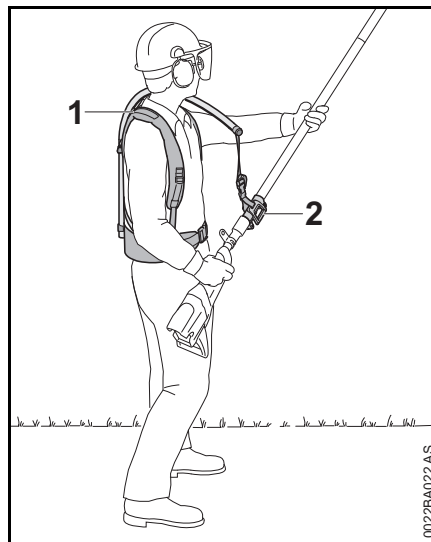

- Put the backpack carrying system (1) on your back and adjust it as described in the instruction leaflet provided.
- Secure the sliding adjuster (2) to the shaft.
- Attach the machine to the carrying strap when working.

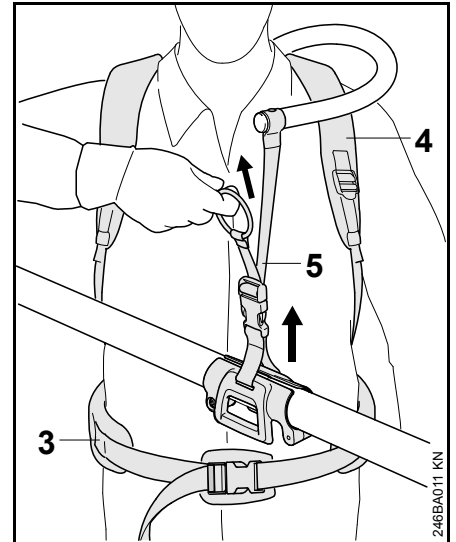

- Adjust the hip belt (3), both shoulder straps (4) and the carrying strap (5).

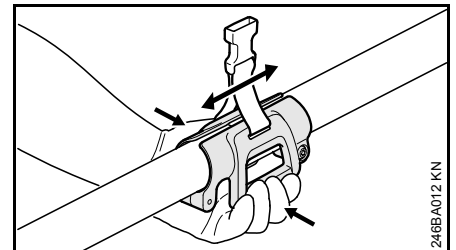

- Squeeze the grips to move the sliding adjuster up or down the shaft.

## Switching On

The starter battery of a factory-new machine is not fully charged.

Recommendation: Fully charge the battery before using it for the first time.

- If necessary, remove the cover from the battery compartment before fitting the battery, i.e. depress both locking tabs to unlock and remove the cover.

### Fitting the Battery

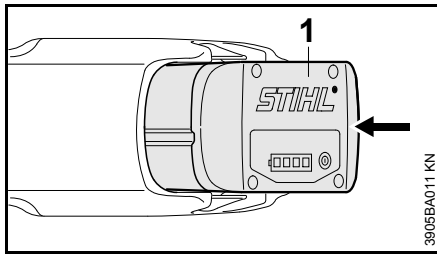

- Insert the battery (1) in the power tool – the battery slides into the compartment – press it down carefully until it snaps into position – the battery must be flush with the top of the housing.

### Switching on the Machine

Your machine cannot be switched on while it is in the transport position.

- Make sure you have a secure and firm footing.
- Stand upright – hold the power tool in a relaxed position.

- Make sure the cutting blades are not touching the ground or any other objects.
- Hold your trimmer with both hands – one hand on the control handle – the other hand on the loop handle or handle hose.

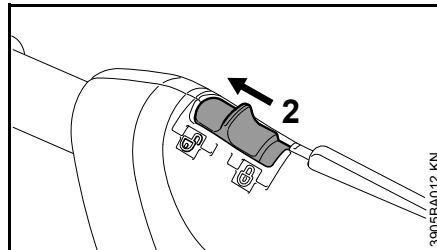

- Unlock the power tool by moving the retaining latch (2) to .

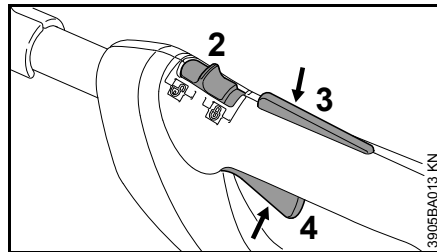

- Push down the trigger switch lockout (3) and depress the trigger switch (4) and hold them in that position.

The motor runs only if the retaining latch (2) is on  and the trigger switch lockout (3) and trigger switch (4) are operated simultaneously.

### Trigger

Motor speed can be controlled with the trigger switch. Depress the trigger switch to accelerate the motor.

## Switching Off

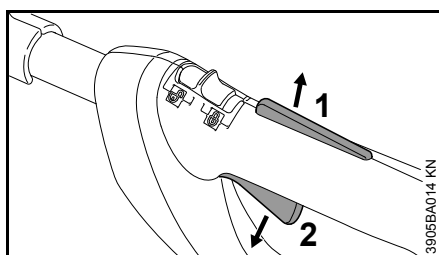

- Release the trigger switch lockout (1) and the trigger switch (2).

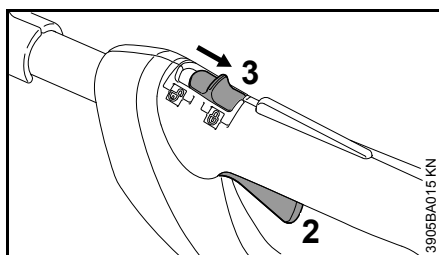

- Move the retaining latch (3) to  – the trigger switch (2) cannot be operated – the power tool is locked to prevent start-up.

Always remove the battery from the power tool during work breaks and after finishing work.

## Removing the battery

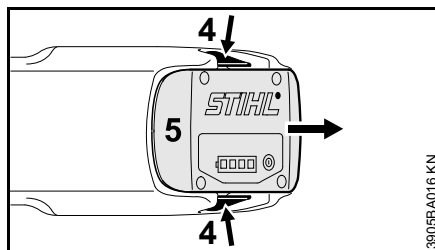

- Press in both locking tabs (4) at the same time to unlock the battery (5).
- Take the battery (5) out of the housing.

When the power tool is not in use, shut it off so that it does not endanger others.

Secure it against unauthorized use.

## Storing the Machine

- Move the retaining latch to .
- Remove the battery.
- Clean the cutting blades, check condition and spray them with STIHL resin solvent.
- Fit the blade scabbard.
- Thoroughly clean the machine, especially the cooling air inlets.
- Store the machine in a dry and secure location out of the reach of children and other unauthorized persons.

### Cover for battery compartment (special accessory)

The cover prevents dirt falling into the empty battery compartment.

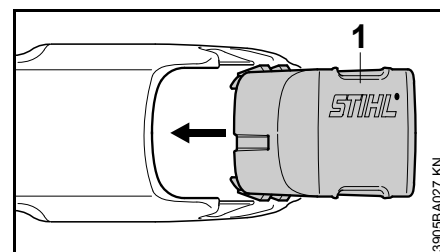

- After finishing work, slide the cover (1) home until it engages audibly in position.

### Storing the Battery

- Take the battery out of the power tool or the charger.
- Store indoors in a dry and safe location. Keep out of the reach of children and other unauthorized persons and protected from contamination.
- Do not store spare batteries unused – use in rotation.

To optimize the life of the battery, store it at a state of charge of about 30%.

### Storing the Charger

- Remove the battery.
- Disconnect the plug from the wall outlet.
- Store the charger indoors in a dry and secure location. Keep out of the reach of children and other unauthorized persons and protected from contamination.

## Sharpening Instructions

When cutting performance and behavior begin to deteriorate, i.e. blades frequently snag on branches: Resharpener the cutting blades.

It is best to have the cutting blades resharpened by a dealer on a workshop sharpener. STIHL recommends a STIHL servicing dealer.

It is also possible to use a flat crosscut sharpening file. Hold the sharpening file at the prescribed angle (see "Specifications").

- Only sharpen the cutting edge – do not file blunt projecting parts of the cutting blade or the cutting blade guard (see "Main Parts and Controls")
- Always file towards the cutting edge.
- The file only sharpens on the forward stroke – lift it off the blade on the backstroke.
- Use a whetstone to remove burr from cutting edge.
- Remove as little material as possible.
- After sharpening, clean away filing or grinding dust and then spray the cutting blades with STIHL resin solvent.

### **NOTICE**

Do not operate your machine with dull or damaged cutting blades. This may cause overload and will give unsatisfactory cutting results.

## Maintenance and Care

The following maintenance intervals apply in normal operating conditions. The specified intervals must be shortened accordingly when working for longer than normal or under difficult cutting conditions (extensive dust, etc.).  Always set the locking lever to  and remove the battery before starting any work on the machine.		before starting work	at the end of work and/or daily	weekly	monthly	yearly	if faulty	if damaged	as required
Complete machine	visual inspection (condition)	X							
	clean		X						
Control handles (locking lever, trigger switch lockout and trigger switch)	Checking operation	X							
	clean		X						X
Intake port for cooling air	visual inspection		X						
	clean								X
All accessible screws, nuts and bolts	retighten								X
Battery	visual inspection	X					X	X	
Battery compartment	clean	X							X
	Check operation (battery ejection)	X	X						
Cutting blades	visual inspection	X					X	X	
	clean <sup>1)</sup>		X						
	sharpen							X	X
Gearbox and con-rod	inspection by a specialist dealer after every 50 hours of operation <sup>2)</sup>								
	topping up of STIHL gear lubricant by a specialist dealer after every 50 hours of operation <sup>2)</sup>								
Safety information labels	replace							X	

<sup>1)</sup> Afterwards spray the blades with STIHL resin solvent

<sup>2)</sup> STIHL recommends STIHL servicing dealers

Main Parts

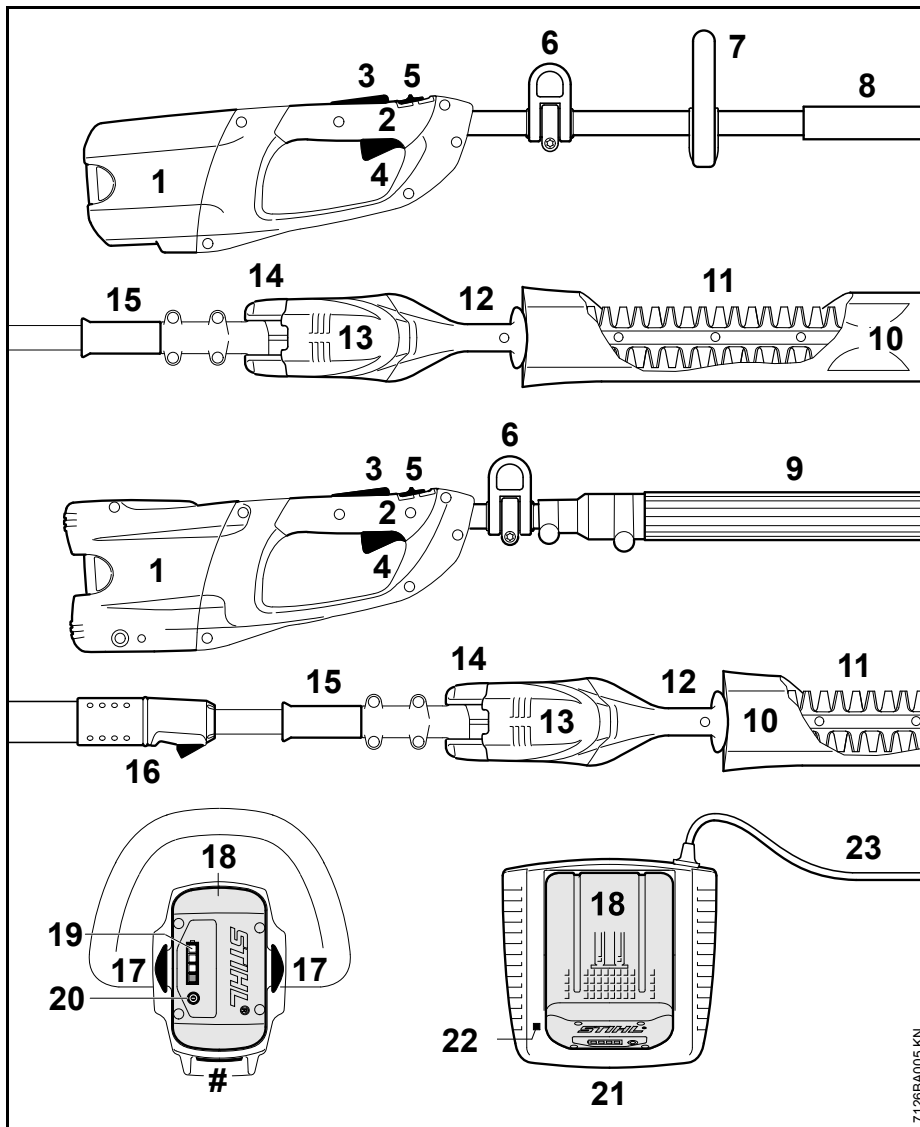

- 1 Battery Compartment
- 2 Control Handle
- 3 Trigger Switch Lockout
- 4 Trigger Switch
- 5 Retaining Latch
- 6 Carrying Ring
- 7 Loop Handle (HLA 65)
- 8 Drive Tube with Handle Hose (HLA 65)
- 9 Handle Hose (HLA 85)
- 10 Blade Scabbard
- 11 Cutting Blades
- 12 Adjusting Grip
- 13 Blade Drive Gear
- 14 Cutter Bar Adjusting Mechanism
- 15 Sliding Sleeve
- 16 Quick-Release Clamp (HLA 85)
- 17 Battery Locking Tabs
- 18 Battery
- 19 Light Emitting Diodes (LED) on Battery
- 20 Push Button
- 21 Charger
- 22 Light Emitting Diode (LED) on Charger
- 23 Power Supply Cord
- # Serial Number

7126BA005 KN

## Definitions

---

1. **Battery Compartment**  
Accommodates the battery in the unit.
2. **Control Handle**  
The handle of the trimmer held by the rear hand.
3. **Trigger Switch Lockout**  
Must be depressed before the trigger switch can be activated.
4. **Trigger Switch**  
Switches the motor on and off and controls the speed of the motor.
5. **Retaining Latch**  
Locks or unlocks the trigger switch.
6. **Carrying Ring**  
Connects the unit to the harness.
7. **Loop Handle (HLA 65)**  
For easy control of machine during cutting work.
8. **Drive Tube with Handle Hose (HLA 65)**  
Encloses and protects the cables between the motor and control handle. For holding and controlling the unit with the hand during operation.
9. **Handle Hose (HLA 85)**  
For holding and controlling the unit with the hand during operation.
10. **Blade Scabbard**  
Covers cutting blades when hedge trimmer is not in use.
11. **Cutting Blades**  
Steel blades for cutting hedges and shrubs.
12. **Adjusting Grip**  
Used to set cutter bar to the required angle.
13. **Blade Drive Gear**  
Converts rotary movement of motor into reciprocating movement of cutting blades.
14. **Cutter Bar Adjusting Mechanism**  
For adjusting the angle of the cutter bar and cutting blades.
15. **Sliding Sleeve**  
Locks and unlocks the cutter bar adjusting mechanism.
16. **Quick-Release Clamp (HLA 85)**  
For adjusting the length of the telescopic drive tube.
17. **Battery Locking Tabs**  
Secure the battery in the unit.
18. **Battery**  
Supplies the motor with electrical power.
19. **Light Emitting Diodes (LED) on Battery**  
Indicate the state of charge and operating condition of the battery.
20. **Push Button**  
For activating light emitting diodes (LED) on battery.
21. **Charger**  
Charges the battery.
22. **Light Emitting Diode (LED) on Charger**  
Indicates charger operating mode and certain problems.
23. **Power Supply Cord**  
Supplies electric current to charger.

## Specifications

### Battery

---

Type: Lithium-ion

Designation: AP, AR

The machine may be operated only with original STIHL AP and AR rechargeable batteries.

Power tool running time is dependent on the energy content of the battery.

STIHL AP series and AR series rechargeable batteries may be charged only with original STIHL AL series chargers.

### Charger

---

#### AL 100

Power supply: 120 V / 60 Hz

Rated current: 1.3 A

Power consumption: 75 W

Charge current: 1.6 A

Insulation: II,  (double insulated)

#### AL 300

Power supply: 120 V / 60 Hz

Rated current: 4.7 A

Power consumption: 330 W

Charge current: 6.5 A

Insulation: II,  (double insulated)

English

**AL 500**

Power supply:	120 V / 60 Hz
Rated current:	4.8 A
Power consumption:	570 W
Charge current:	12 A
Insulation:	II,  (double insulated)

**Cutting Blade**

---

Cutting length:	500 mm (20 in)
Tooth spacing:	33 mm (1.3 in)
Stroke rate:	3,000/min
Sharpening angle to horizontal:	45°

**Weight**

---

without battery, with cutting blade, without blade scabbard

HLA 65:	3.5 kg (7.7 lbs)
HLA 85:	4.4 kg (9.7 lbs)

**Transporting Batteries**

---

STIHL batteries comply with the requirements set forth in UN-Manual ST/SG/AC.10/11/Rev.5/Part III, Subsection 38.3.

Commercial air, vessel and ground transportation of lithium ion cells and batteries is regulated. The battery is classified as a UN 3480, Class 9, packaging group 2 product. Shipping it,

either as a complete tool or the battery, requires compliance with all applicable shipping regulations. Check with the ground, vessel, air cargo or passenger airline to determine if transport is prohibited or subject to restrictions or exemptions prior to shipping or travel.

Normally, no further conditions have to be fulfilled by the user to transport STIHL batteries by road to the power tool's operating site. Check and comply with any special regulations that may apply to your situation.

**FCC 15 Compliance Statement for Power Tool and Charger**

---

This device complies with part 15 of the FCC Rules. Operation is subject to the following two conditions:

- this device may not cause harmful interference.
- this device must accept any interference received, including interference that may cause undesired operation.

Note: This equipment has been tested and found to comply with the limits for a Class B digital device, pursuant to part 15 of the FCC Rules. These limits are designed to provide reasonable protection against harmful interference in a residential installation. This equipment generates, uses and can radiate radio frequency energy and, if not installed and used in accordance with the instructions, may cause harmful interference to radio communications. However, there is no guarantee that interference will not occur in a particular installation. If this equipment does cause

harmful interference to radio or television reception, which can be determined by turning the equipment off and on, the user is encouraged to try to correct the interference by one or more of the following measures:

- reorient or relocate the receiving antenna,
- increase the separation between the equipment and receiver,
- connect the equipment into an outlet on a circuit different from that to which the receiver is connected,
- consult the dealer or an experienced radio/TV technician for help.

Do not change or modify this product in any way unless specifically allowed in this manual, since this could void your authority to operate it.



## Troubleshooting

Always remove the battery from the machine before starting any work on the machine.

Fault	Cause	Remedy
Machine does not start when switched on	Adjustable cutter is in transport position	Swing adjustable cutter into area of operation
	No electrical contact between machine and battery	Remove battery, visually inspect the contacts and reinsert the battery
	Battery has low charge (1 LED on battery flashes green)	Charge battery
	Battery too hot / too cold (1 LED on battery is red)	Let the battery cool down / let the battery warm up gradually at temperatures of approx. 15 °C - 20 °C (59°F - 68°F)
	Battery fault (4 LED on battery flashes red)	Remove battery from the machine and reinsert it. Turn on the machine – if the LEDs still flash, the battery is faulty and must be replaced
	Unit too hot (3 LEDs on battery are red)	Let the machine cool off
	Electromagnetic malfunction or fault in machine (3 LED on battery flashes red)	Remove battery from the machine and reinsert it. Turn on machine – if the LEDs still flash, the machine is faulty and must be checked by a servicing dealer <sup>1)</sup>
	Moisture in the machine and/or battery	Let the machine/battery dry
Machine switches off in operation	Battery or machine electronics too hot	Remove battery from the machine, let battery and machine cool off
	Electrical or electromagnetic malfunction	Remove battery and reinsert it

**Always remove the battery from the machine before starting any work on the machine.**

Fault	Cause	Remedy
Running time is too short	Battery is not completely charged	Charge battery
	Service life of battery has been reached or exceeded	Check battery <sup>1)</sup> and replace
	Blade clogged/dirty	Clean blades, spray with STIHL resin solvent
	Blade bent	Have blade checked by a servicing dealer <sup>1)</sup>
Battery gets stuck during insertion in the machine/charger	Guides dirty	Carefully clean guides
Battery does not charge although the LEDs on the charger are green	Battery too hot / too cold (1 LED on battery is red)	Let the battery cool down / let the battery warm up gradually at temperatures of approx. 15 °C - 20 °C (59°F - 68°F)  Operate the charger only in a closed, dry space at ambient temperatures of +5 °C to +40 °C (41°F - 104°F)
LED on charger flashes red	No electrical contact between charger and battery	Remove battery and reinsert it
	Battery fault (4 LEDs on battery flash red for approx. 5 seconds)	Remove battery from the machine and reinsert it. Turn on the machine – if the LEDs still flash, the battery is faulty and must be replaced
	Fault in charger	Have charger checked by a servicing dealer <sup>1)</sup>

<sup>1)</sup> STIHL recommends STIHL servicing dealers

## Maintenance and Repairs

Users of this unit should carry out only the maintenance operations described in this manual. STIHL recommends that other repair work be performed only by authorized STIHL servicing dealers.

Warranty claims following repairs can be accepted only if the repair has been performed by an authorized STIHL servicing dealer using genuine STIHL replacement parts.

Genuine STIHL parts can be identified by the STIHL part number, the **STIHL** logo and, in some cases, by the STIHL parts symbol . The symbol may appear alone on small parts.

## Battery Recycling

### Battery Recycling Information



STIHL is committed to the development of products that are environmentally responsible. This commitment does not stop when the product leaves the STIHL dealer. STIHL has partnered with the RBRC (Rechargeable Battery Recycling Corporation) to promote the collection and recycling of spent STIHL lithium ion batteries in the United States and Canada. The RBRC seal can be found on every STIHL rechargeable battery and indicates that STIHL has prepaid for recycling the battery. The seal has a toll free phone number (1-800-822-8837) that connects you to information on battery recycling locations and information on battery disposal bans or restrictions in your area. You can also return your spent battery to any STIHL authorized servicing dealer for recycling free of charge.

## Disposal

Observe all country-specific waste disposal rules and regulations.

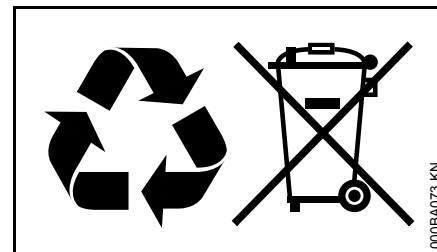

STIHL products must not be thrown in the garbage can. Take the product, accessories and packaging to an approved disposal site for environment-friendly recycling.

Contact your STIHL servicing dealer for the latest information on waste disposal.

## Trademarks

### STIHL Registered Trademarks

---

STIHL®

**STIHL**®



The color combination orange-grey (U.S. Registrations #2,821,860; #3,010,057, #3,010,058, #3,400,477; and #3,400,476)



AutoCut®

EASYSTART®

FARM BOSS®

iCademy®

MAGNUM®

MasterWrench Service®

MotoMix®

OILOMATIC®

Rock Boss®

STIHL Cutquik®

STIHL DUROMATIC®

STIHL Quickstop®

STIHL ROLLOMATIC®

STIHL WOOD BOSS®

TIMBERSPORTS®

WOOD BOSS®

YARD BOSS®

### Some of STIHL's Common Law Trademarks

---



4-MIX™

BioPlus™

Easy2Start™

EasySpool™

ElastoStart™

Ematic™

FixCut™

HT Plus™

IntelliCarb™

Master Control Lever™

Micro™

Pro Mark™

Quad Power™

Quiet Line™

STIHL Arctic™

STIHL Compact™

STIHL HomeScaper Series™

STIHL Interchangeable Attachment Series™

STIHL M-Tronic™

STIHL MiniBoss™

STIHL MotoPlus 4™

STIHL Multi-Cut HomeScaper Series™

STIHL OUTFITTERS™

STIHL PICCO™

STIHL PolyCut™

STIHL PowerSweep™

STIHL Precision Series™

STIHL Protect™

STIHL RAPID™

STIHL SuperCut™

STIHL Territory™

TapAction™

TrimCut™

This listing of trademarks is subject to change.

Any unauthorized use of these trademarks without the express written consent of ANDREAS STIHL AG & Co. KG, Waiblingen is strictly prohibited.

## Addresses

**STIHL Inc.**  
536 Viking Drive  
P.O. Box 2015  
Virginia Beach, VA  
23452-2015