

## Warranty Conditions

The manufacturer warrant that this machine is free from defects in material and workmanship. This warranty is limited to making good or replacing any part which appears upon inspection by the manufacturer or his agent to be defective in material or workmanship.

The warranty for the engine used to power this machine may differ from the warranty for the other components. Refer to the engine warranty statement in the Engine Owner's Manual which has been included with this machine. As the warranty may differ, you are advised to read the engine warranty carefully.

For other items this warranty shall apply for a period of 48 months from date of purchase for domestic use only. However these items are **not** warranted for commercial or industrial use.

This warranty does not obligate the manufacturer, his agents or dealers to bear the transport costs incurred in the repair or replacement of any defective part. This warranty excludes fair wear and tear, or any damage caused by misuse or abuse. Parts such as blades, blade bolts, V-belts, and spark plugs, which can be subjected to use beyond their normal intended working capacity are also excluded.

This warranty is void if parts other than genuine have been used or if repairs or alterations have been made without the manufacturer's written authority. The above warranty does not exclude any condition or warranty implied by the Trade Practices Act 1974 or any other relevant legislation which implies any condition which cannot be excluded.

**REMEMBER: PROOF OF PURCHASE IS THE RESPONSIBILITY OF THE OWNER AND IS RECOMMENDED PRIOR TO WARRANTY WORK BEING UNDERTAKEN. REPAIRS MUST BE CARRIED OUT BY AN AUTHORISED DEALER OR AGENT AND GENUINE SPARE PARTS MUST BE USED OR YOUR WARRANTY WILL BE VOID.**

The manufacturer reserves the right to make changes and add improvements to its product at any time without notice or obligation. The Company also reserves the right to discontinue manufacture of any product at its discretion at any time.

### For your Record:

Retailers Name: .....Address: .....

Phone No: .....Model No: .....

Serial No: .....Date of Purchase:.....

No. 94.6010707

© Copyright 2015		
Revision A		
Leester		

# LawnMaster®

## Rotary Mowers Owner's Manual

[www.steelfort.co.nz](http://www.steelfort.co.nz)

**Note:** Please read the following instructions before use. This book contain important information on SAFETY ,ASSEMBLY,OPERATION AND MAINTENANCE.  
Please put the manual and the engine book let aside for your future Reference. They illustrate Important information about your mower.

## SAFETY INSTRUCTIONS

- ★ Never mow while barefoot or wearing open sandals or thongs. Wear long trousers and heavy shoes
- ★ Know your controls. Read the owner's manual carefully. Learn how to stop the engine quickly in any emergency
- ★ Make sure the lawn is clear of sticks, stones, bones, wire and debris. They could be thrown by the blade
- ★ Stop the engine and disconnect the spark plug wire before clearing blockages, checking, or working on the mower.
- ★ Before using, always visually inspect to see that blades, blade bolts and cutter assembly are not worn or damaged. Replace worn or damaged blades in sets to preserve balance.

### DAMAGED BLADES AND WORN BOLTS ARE MAJOR HAZARDS.

- ★ Check all nuts, bolts and screws often; always be sure the mower is in a safe operating condition. Use only genuine replacement parts.
- ★ Refuel outdoors only. Do not smoke while fuelling engine. Add fuel before starting the engine. Never remove the cap off the fuel tank or add fuel while the engine is running or the engine is hot. If fuel is spilled, do not attempt to start the engine but move the machine away from the area of the spill and avoid creating any source of ignition until fuel vapours have dissipated.
- ★ Do not mow whilst people, especially children or pets are in the mowing area.
- ★ Replace worn or faulty silencers (muffler)
- ★ Mow only in good daylight.
- ★ Never use the mower unless the grass catcher or guards (rear flap) provided by the manufacturer are in position.
- ★ Start the engine carefully with feet well away from the blade.
- ★ Do not operate the engine in a confined space where exhaust fumes (carbon monoxide) can collect.
- ★ Stop the engine whenever you leave the mower, even for a moment.
- ★ Do not allow children or people unfamiliar with these instructions to use the mower.
- ★ Store the mower in a well-ventilated room away from naked flames such as may be found in hot water heaters.
- ★ Do not over-speed the engine or alter governor settings. Excessive speed is dangerous and shortens the mower life.
- ★ It is advisable to wear suitable eye protection when operating a mower.
- ★ Turn the fuel off at the conclusion of mowing and reduce the throttle setting during engine run-out.
- ★ Store fuel in a cool place in a container specifically designed for the purpose. In general, plastic containers are unsuitable.
- ★ Stop the engine, disconnect the spark plug wire and inspect the mower if: a) the mower begins to vibrate abnormally; or b) after striking a foreign object.
- ★ Never cut grass while walking backwards.
- ★ Stop the engine before pushing the mower across gravel drives, walks or roads.
- ★ Walk, never run.
- ★ Mow across the face of slopes, never up and down. Exercise extreme caution when changing direction on slopes. Do not mow excessively steep slopes.
- ★ Never pick up or carry a mower when it is operating.

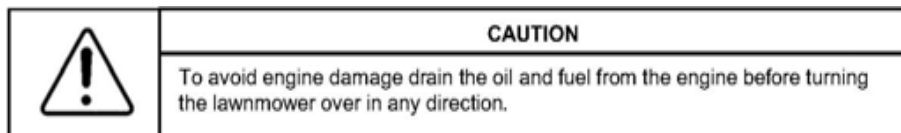

- greater evaporation
- temperature extremes
- erosion

Raising the cut height and using mulch mowing follows the *best practice* for nurturing a healthier more attractive lawn with less water usage.

### BENEFITS FOR YOU

Because you mulch as you mow the time and cost savings are also significant:

- ★ Eliminating raking of leaves before mowing (Mulch mowing picks up and converts fallen leaves into mulch).
- ★ Eliminating raking of cut grass.
- ★ Saves time spent emptying the catcher.
- ★ Automatically disposing of grass clippings.
- ★ Eliminating the need to dispose of clippings at the refuse tip.

### MULCH MOWING INFORMATION (continued)

USEFUL MULCH MOWING TIPS Mulch mowing is an art form and to produce the best results consistently, follow these useful hints:

#### ★ Do not attempt to mulch if the grass is too wet.

Wet grass tends to clump together and does not evenly spread out. It also clogs up the underside of the base.

#### ★ Do not mulch mow on too low a cutting height.

Remember the maximum cut should be 25mm off the top of the grass, or 1/3rd the grass (blade) height, whichever is the lesser amount. Refer to figure 20.

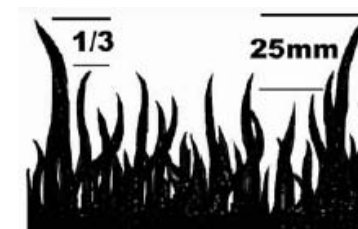

Figure 20. Grass height

#### ★ Do not push the mower too fast.

To obtain the best finish it may be necessary to regulate the ground speed.

#### ★ Run the engine at full throttle.

Running the engine at low speed does not allow the blades to mulch the grass efficiently.

#### ★ Keep the mulch blades sharp.

The mulch blades are designed to cut and re-cut the blades of grass. If the mulch blades are not kept sharp, mulching performance will be reduced.

#### ★ Keep the underside of the mower and mulch plug clean.

Build-up of grass under the mower base blocks the airflow created by the mulch blade and reduces the mulching performance.

#### ★ If the conditions for mulch mowing are not ideal and some clipping trails are visible after cutting maybe necessary to:

1. Fit the grass catcher and catch mow.
2. Re-mow over the visible clippings.
3. Raise the cut height.
4. Rake the clippings up after mowing.

Note: The pawl must always be orientated so that the side with the large flat face (M) will come in contact with the flat faces inside the pinion gear (N) The orientation is important to ensure that the pawl will drive the pinion gear when the clutch is engaged). Refer to figure 19.

- ★ Replace the wheel and retain using the tension washer and the nyloc nut (K). Tension the nut just enough to remove the side to side movement of the wheel.
- ★ Replace the wheel caps (A) and re-attach the spark plug lead and lower the wheels to the ground.

#### MAINTENANCE -Mulch mowers (only)

##### Mulching Equipment

For optimum mulching performance

★	The mulch blades are to be kept sharp.
★	Maintain the blade sharpening angle when sharpening.
★	Keep the cutting edge feather free when sharpening.
★	Keep the underside of the mower deck and the mulch plug free of build-up.
★	Refer to the Cleaning section on page 7.

#### MULCH MOWING INFORMATION

Some models are fitted with an option for mulch mowing.

A mulch plug is supplied with these mowers and it is installed in the rear discharge chute (as noted in the "OPERATION" section of this manual) to perform mulch mowing.

The following information provides advice on mulch mowing .

#### MULCH MOWING

The mulch mowing setup reduces the grass clippings into very fine particles.

The design allows for the even distribution of the grass particles at the base of the lawn.

The mulched clippings can then:

- ★ Break down quickly, releasing nutrients into the soil, saving on fertilizer costs.
- ★ Reduce evaporation of moisture from the soil which reduces watering costs and effort.
- ★ Help to control temperature extremes protecting the roots of the grass.
- ★ Assist in controlling soil erosion.

#### BENEFITS TO YOUR LAWN

Research has shown that lawns are usually cut *too short*,

Grass, like any other plant life, relies on photosynthesis to regenerate and survive.

Reduced leaf size (from cutting too low) can seriously effect a lawn by:

- ★ Making it more susceptible to disease.
- ★ Encouraging weeds to take hold.
- ★ Exposing the soil to:

## INTRODUCTION

***Congratulations on your purchase of a this domestic rotary lawnmower.***

This manual covers the setting up, operation and maintenance of the domestic rotary lawnmower. Please read and understand this owner's manual before using the mower. If any point is unclear, contact The manufacturer or agent.

To emphasise special information the following **WARNING** and **CAUTION** highlights are used.

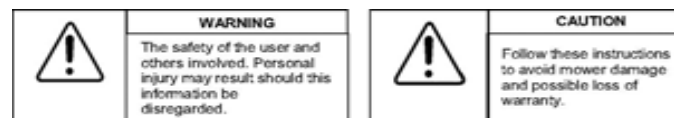

### MANUAL CONTENTS

	Page
★ Safety instructions	1
★ Introduction	2
★ Setting up	3
★ Operation -All Models	3
-Mulch Models (only)	4
- Self Propelled Models (only)	5
★ Maintenance -All Models	6 & 7
- Self Propelled Models (only)	7,8 &9
-Mulch Models (only)	9
★ Mulch Mowing Information	9&10
★ Warranty conditions	11
<b>CARTON CONTENTS:</b>	<b>Quantity</b>
★ Domestic rotary lawnmower	1
★ Owner's manual	1
★ Engine owner's manual	1
★ Grass catcher	1

NB.Mowers which have the mulch option will have the mulch Plug fitted into the rear chute of the mower.

**If when unpacking your new lawnmower it is found that there are items missing contact service dealer or agent.**

## SETTING UP

### Preliminary

★ Open the lawn mower cardboard carton carefully folding back the carton top flaps.

★ Lift out the plastic grass catcher components.

★ With the aid of a second person carefully lift the lawn mower out of the cardboard carton and place on a level surface.

★ Loosen the two handle bar pivot bolt knobs (A) (where fitted).

★ Fold the handle bars out straight, inline with the lower handle bars. Tighten the two handle bar pivot bolt knobs (A) or the cam locks (B) to secure the handle bars in position. Refer to figure 1.

★ Remove and discard the white protective packing sheet from the mower.

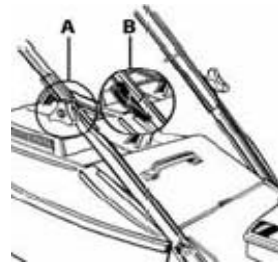

Figure 1. Handle bar pivot bolt knobs and camlocks

### Engine oil

**Oil must be added before attempting to start the engine otherwise damage to the engine will occur.**

Refer to the engine owner's manual.

The 4 stroke engine fitted to the lawnmower **is shipped with no oil** in the sump.

### Engine fuel

Refer to the engine owner's manual. ground.

Use only fresh unleaded fuel in the lawnmower engine.

## OPERATION -All mowers

### Adjusting the cut height-

refer figure 3.

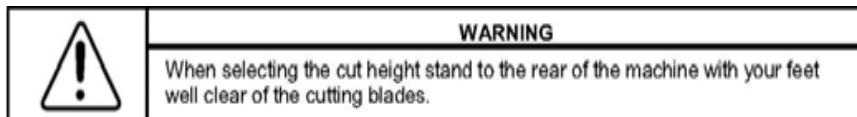

The lawnmower has ten height settings controlled by the height adjustment lever located at the rear right hand wheel.

★ Grasp the height adjustment lever (1) and pull the lever away from the base to disengage the lever from the height adjustment rack (2).

★ Move the lever either forwards or backwards to the desired position and release the lever so as to engage in the height adjustment rack.

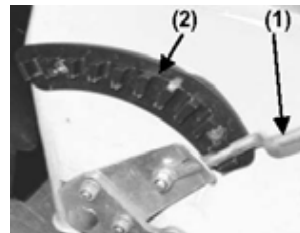

Figure 3. Height adjustment

★ To adjust the clutch spring stretch rotate the thumb wheel (A) on the cable support block (one click at a time).

To increase the stretch rotate the thumb wheel (A) in an anti-clockwise direction.

To decrease the stretch rotate the thumb wheel (A) in a clockwise direction.

Refer to figure 17.

★ Check that the clutch disengages by pulling the mower backwards (with the clutch engagement lever released) - the rear wheels should free wheel. If not do not attempt to start the mower as it may drive off unattended.

★ If the mower free wheels test the mower at all engine speeds ensuring that it self-disengages when the drive clutch engagement lever is released.

★ If you still experience problems, please contact with service dealer or agent.

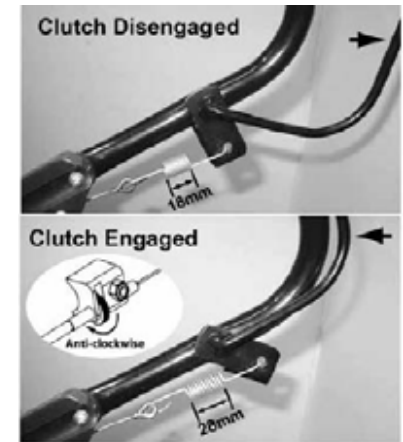

figure 17 . Clutch adjustment

## MAINTENANCE -Self Propelled Mowers (only)

### Drive wheel cleaning and drive pawl lubrication – refer to figure 18 and 19

Every 50 hours :-

★ Disconnect the spark plug lead.

★ Support the rear wheels off the ground and remove the wheel caps (A).

★ Remove the nyloc nut and tension washer (K) retaining the wheel (D) to the

★ Remove the wheel (D) from the axle and clean the inside of the wheel hub.

★ Remove the circlip (E), outer washer (F), outer bush (G), pinion gear (H) and pawl (J) from the drive shaft (recording the orientation of the pinion gear and the pawl to ensure correct reinstallation).

★ Clean all components.

★ Lightly grease the pawl(J),the slot in the shaft, bushes (G) and the inside of the pinion gear (H) with light general purpose grease then refit the components onto the drive shaft in the NGrass Catcher ect orientation,

Note: The pinion gear (H) is marked "R" on one side and "L" on the other. The pinion gear (H) is to be fitted with the "R" displayed when fitted on the right hand drive side of the mower and with the "L" displayed when fitted on the left hand drive side. Refer to figure 19. The right and left side of the mower is indicated while standing in the operator position.

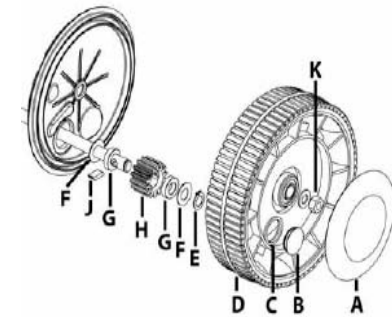

figure 18. Rear drive wheels

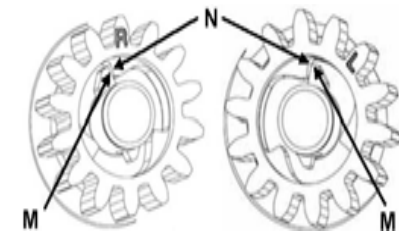



figure 19. Rear wheel pinions and pawls

## MAINTENANCE -All mowers

### Cleaning

To ensure safe operation and long life it is recommended to clean the mower after every use. This will prevent corrosion, overheating and fire risk while ensuring ultimate performance.

#### Cleaning the Underside of the Mower

	<b>CAUTION</b>
	Always ensure the engine is stopped and the spark plug lead is removed before attempting any maintenance on the mower.

- ★ Place the mower outdoors on a flat surface.
- ★ Set the cut height to maximum.
- ★ With the engine stopped, remove the grass catcher or mulch plug and lift open the discharge flap.
- ★ Use a garden hose to wash out all the grass clippings.
- ★ Inspect the underside and repeat the cycle if still not clean.



	<b>CAUTION</b>
	Do not hose the engine as water can damage the air cleaner and ignition system.

#### Cleaning the Upper side of the Mower

- ★ Use a dry cloth or soft brush to remove all loose clippings.
  - ★ Use a damp cloth with mild detergent to clean away oil or other grime.
  - ★ Wash the grass catcher and/or mulch plug separately from the mower with a hose.
- Wash all clippings out of the inside, outside and from the grass catcher mesh.
- ★ Let the mower dry before storing.

## MAINTENANCE -Self Propelled Mowers (only)

### Adjusting the Drive Cable-refer figure 17.

	<b>WARNING</b>
	If cable adjustment is necessary ensure that the drive disengages before starting the mower or it may drive off unattended. This can be checked by pulling the mower backwards (with the clutch engagement lever released) - the rear wheels should free wheel.
	<b>CAUTION</b>
	Do not over tighten the cable assembly.

### Every 25 hours:

- ★ Measure the length of the clutch spring(18mm) when the clutch engagement lever is in the disengaged position. Refer to figure17.
- ★ Push the clutch engagement lever forward until it touches the handlebar (drive engaged position). The clutch spring should be stretched to 28mm (10mm longer). Refer to figure 17.

## OPERATION -Mulch Mowers (only) Installing the Mulch Plug

- ★ With the engine stopped, raise the rear flap of the mower and remove the grass catcher (if fitted)
- ★ Insert the long right hand side of the mulch plug first into the rear chute of the mower. Refer to figures 7 and 9.
- ★ Rotate the left hand side into the rear chute of the mower and push it as far forward as possible.
- ★ Align the two locating pins (1) (on the underside of the mulch plug) with the slots (2) in the top surface of the back ledge (3) of the mower base and lower the mulch plug until the lower face rests flat on top of the back ledge of the mower base. Refer to figures 8 & 10.
- ★ Lower the rear flap. To ensure the mulch plug is correctly seated, the rear flap should close against the vertical face of the mulch plug legs with clearance to the horizontal extensions.

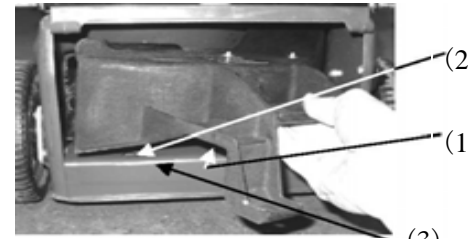

Figure 7. Mulch plug installation (A) - Push Mower

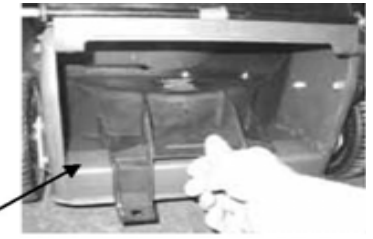

Figure 8. Mulch plug installation (B) - Push Mower

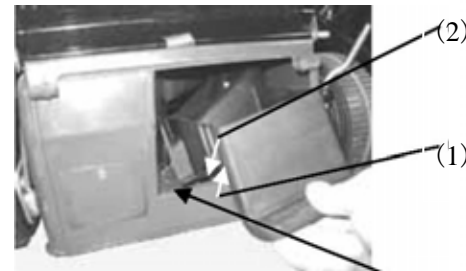

Figure 9. Mulch plug installation (A) - Self propelled Mower



Figure 10. Mulch plug installation (B) - Self Propelled Mower



### Removing the Mulch Plug

- ★ With the engine stopped, raise the rear flap of the mower.
- ★ Grasp the rear of the mulch plug and lift up and away from the mower. Refer to figures 8 and 10.
- ★ Guide the mulch plug out by rotating the shorter left hand side to the right and then guiding the longer right hand section until clear of the mower. Refer to figures 7 and 9



## OPERATION -All mowers

### To Start the engine

Refer to the engine owner's manual for detailed starting procedure. Ensure that the engine oil is at the correct level and that the fuel tank is full of fresh unleaded fuel.

- ★ Move the throttle control lever to the :- "CHOKE"  position (where fitted) - or the "FAST"  position and prime the engine. Refer to the engine owner's manual.

★ Grasp rope handle and pull slowly until resistance is felt. Then pull the cord rapidly to overcome compression, prevent kickback and start engine. Repeat if necessary

- ★ If a "Choke"  is fitted move the throttle control lever to the "FAST"  position after the engine starts .

### To Stop the engine

Move the throttle control lever to the "STOP" position 

Wait till the engine comes to a complete stop before removing or fitting the grass catcher or mulch plug to the mower, or attempting any maintenance work on the mower.

OPERATION -Self Propelled mowers only

### Engaging the Drive

- ★ Start the engine and move the throttle  to the "FAST" position.

★ Push slowly on the clutch engagement lever to engage the self-propelled drive to the rear wheels. Refer to figure 13.

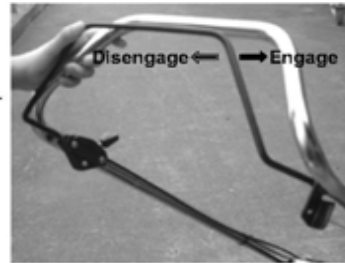



Figure 13. Clutch engagement lever

### Disengaging the Drive

- ★ Release the clutch engagement lever.
- ★ Allow the clutch engagement lever to return to the disengaged position.

	<b>CAUTION</b>
	To avoid excessive clutch wear, do not hold the engagement lever in a semi-engaged position.

## MAINTENANCE -All mowers

	<b>WARNING</b>
	Before carrying out any maintenance on the mower remove the spark plug lead from the spark plug to prevent accidental starting.

### Engine air cleaner

Refer to the engine owner's manual for detailed maintenance instructions. The engine air cleaner elements must be serviced after every 25 hours of normal mowing. The elements must be serviced more regularly if the mower is used in dusty conditions. Replace immediately if the element is damaged.

### Spark plug

Refer to the engine owner's manual for detailed maintenance instructions. For best results, remove the spark plug every 50 hours for gap checking and replace every 100 hours of use. Replace the spark plug at any time if it is found that the electrodes are pitted or burned or the porcelain cracked. For replacement refer to engine owner's manual for correct spark plug.

## Muffler

Check the condition of the muffler periodically for rust and cracks. Replace if found to be damaged as this can lead to increased exhaust noise. Replace only with a genuine original equipment part.

### Blades -refer figure 15

Check the condition of the blades and central fasteners at regular intervals, or after striking a solid object, or if the mower begins to vibrate abnormally. The blades with use, will lose their sharp edge and the quality of the grass finish will deteriorate. When this happens, all the blades should be removed and replaced with a new set of blades. Always use genuine replacement blades and only replace blades in sets to maintain balance.

## MAINTENANCE -All mowers

### Cutting Assembly

	<b>WARNING</b>
	Always ensure the engine is stopped and the spark plug lead is removed before attempting any maintenance on the mower. Secure the mower safely when tilted upwards to access the underside.

- ★ With the engine stopped, remove the spark plug lead and grass catcher or mulch plug.
- ★ Set the height of cut lever to the high cut position, and fold the handle bars.
- ★ Tilt the mower so the spark plug is up.
- ★ Inspect the cutting assembly for damage and wear.
- ★ Check the disc retaining bolts. Tighten the centre bolt to 57-62Nm and the three concentric bolts to 8-11Nm.
- ★ Return the mower to its normal position and re-attach the spark plug lead.

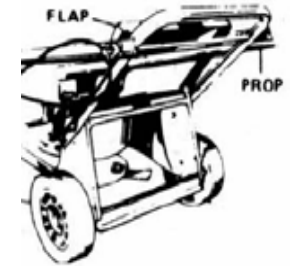



Figure 16. Blade change

### Blade Change-refer figure 15 and 16

	<b>WARNING</b>
	Always ensure the engine is stopped and the spark plug lead is removed before attempting any maintenance on the mower. Always replace blades and blade fixings in complete sets to maintain balance.

- ★ With the engine stopped, spark plug lead and grass catcher or mulch plug removed, open the discharge flap and prop in the open position. Refer to figure 15.
- ★ Set the mower to the high cut position and fold the handle bar forward.
- ★ Rotate the cutting assembly carefully to access the blade retaining bolts. Refer to figure 16
- ★ Using gloves and a suitable spanner, remove the blade assembly.

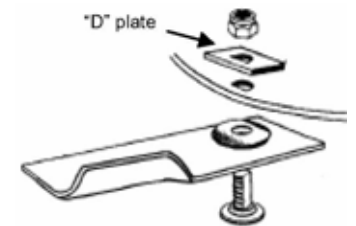

Figure 16. Blade Attachments

- ★ Retain the "D" plates and discard the blades and fasteners. NB. Mowers fitted with a circular cutting disc must be fitted with a "D" Plate (as shown in figure 16)
- ★ Fit new blades and fasten in the correct order. Refer to figure 16.
- ★ Tighten the blade retaining nuts firmly to 16Nm.
- ★ Remove the flap prop, close the discharge flap and re-attach the spark plug lead.